Copyright and Warranty Notice

The information in this document is subject to change without notice and does not represent a commitment on part of the vendor, who assumes no liability or responsibility for any errors that may appear in this manual.

No warranty or representation, either expressed or implied, is made with respect to the quality, accuracy or fitness for any particular part of this document. In no event shall the manufacturer be liable for direct, indirect, special, incidental or consequential damages arising from any defect or error in this manual or product.

Product names appearing in this manual are for identification purpose only and trademarks and product names or brand names appearing in this document are the property of their respective owners.

This document contains materials protected under International Copyright Laws. All rights reserved. No part of this manual may be reproduced, transmitted or transcribed without the expressed written permission of the manufacturer and authors of this manual.

If you do not properly set the motherboard settings causing the motherboard to malfunction or fail, we cannot guarantee any responsibility.

KT7/KT7-RAID/KT7A/KT7A-RAID

Motherboard User's Manual

Index

CHAPTER 1. INTRODUCTION OF KT7/KT7-RAID/KT7A/KT7A-RAID FEATURES

1-1.	FEATURES OF KT7/KT7-RAID MOTHERBOARD	1-1
1-2.	FEATURES OF KT7A/KT7A-RAID MOTHERBOARD	1-2
1-3.	SPECIFICATIONS	1-3
1-4.	ITEM CHECKLIST	1-6
1-5.	LAYOUT DIAGRAM FOR KT7/KT7-RAID	1-7
1-6.	LAYOUT DIAGRAM FOR KT7A/KT7A-RAID	1-8
1-7.	THE SYSTEM BLOCK DIAGRAM FOR KT7/KT7-RAID	1-9
1-8.	THE SYSTEM BLOCK DIAGRAM FOR KT7A/KT7A-RAID	1-10

CHAPTER 2. INSTALLING THE MOTHERBOARD

2-1.	INSTALLING THE MOTHERBOARD TO THE CHASSIS	2-2
2-2.	INSTALLATION OF THE AMD ATHLON™ AND DURON™ CPU	2-3
2-3.	INSTALLING SYSTEM MEMORY	2-6
2-4.	CONNECTORS, HEADERS AND SWITCHES	2-9

CHAPTER 3. INTRODUCING THE BIOS

3-1.	CPU SETUP [SOFT MENU™ III]	3-3
3-2.	STANDARD CMOS FEATURES SETUP MENU	3-8
3-3.	ADVANCED BIOS FEATURES SETUP MENU	3-13
3-4.	ADVANCED CHIPSET FEATURES SETUP MENU	3-17
3-5.	INTEGRATED PERIPHERALS	3-23
3-6.	POWER MANAGEMENT SETUP MENU	3-28
3-7.	PNP/PCI CONFIGURATIONS SETUP MENU	3-38
3-8.	PC HEALTH STATUS	3-42
3-9.	LOAD FAIL-SAFE DEFAULTS	3-43
3-10.	LOAD OPTIMIZED DEFAULTS	3-43
3-11.	SET PASSWORD	3-44
3-12.	SAVE & EXIT SETUP	3-45
3-13.	EXIT WITHOUT SAVING	3-45

CHAPTER 4. RAID SETTING GUIDE

4-1.	THE FEATURES OF RAID ON THE KT7-RAID/KT7A-RAID	4-1
4-2.	RAID SETUP ON THE KT7-RAID/KT7A-RAID	4-1

4-3.	THE BIOS SETTING MENU	4-2
CHAPTER 5. HPT370 SOFTWARE INSTALLATION		
5-1.	DOS®	5-1
5-2.	WINDOWS® 9X	5-1
5-3.	WINDOWS NT® 4.0	5-5
5-4.	WINDOWS® 2000	5-8
5-5.	HPT370 UTILITY INSTALLATION GUIDE	5-10
APPENDIX A VIA SERVICE PACK DRIVERS INSTALLATION FOR WINDOWS® 98 SE		
APPENDIX B INSTALLING THE VIA SERVICE PACK DRIVERS FOR THE WINDOWS® NT 4.0 SERVER / WORKSTATION		
APPENDIX C VIA SERVICE PACK DRIVER INSTALLATION FOR WINDOWS® 2000		
APPENDIX D USB DRIVER INSTALLATION GUIDE		
APPENDIX E INSTALLING THE VIA HARDWARE MONITOR SYSTEM		
APPENDIX F BIOS UPDATE GUIDE		
APPENDIX G TROUBLESHOOTING (NEED ASSISTANCE?)		
	MOTHERBOARD TROUBLESHOOTING:	G-1
	RAID TROUBLESHOOTING	G-6
	 TECHNICAL SUPPORT FORM	G-8
APPENDIX H HOW TO GET TECHNICAL SUPPORT		

Chapter 1. Introduction of KT7/KT7-RAID/KT7A/KT7A-RAID Features

1-1. Features of KT7/KT7-RAID Motherboard

This motherboard is designed for AMD Socket A Athlon™ and Duron™ CPUs. It supports the AMD Socket-A structure, with up to 1.5GB of memory, super I/O, and Green PC functions.

The KT7/KT7-RAID uses the VIA Apollo KT133 chipset to make the evolutionary move from PC 100 to PC 133, increasing the speed of the system and memory buses from 100 MHz to 133 MHz. Its' 133 MHz memory interface supports the wide range of PC 133 memory devices now on the market.

The KT7/KT7-RAID has a built in Ultra ATA/66 function. This means that it can provides speedier HDD throughput that boosts overall system performance. Ultra ATA/66 is the new standard for IDE devices. It enhances existing Ultra ATA/33 technology by increasing both performance and data integrity. This new high-speed interface doubles the Ultra ATA/33 burst data transfer rate to 66.6 Mbytes/sec. The result is maximum disc performance using the current PCI local bus environment. Another benefit is, you can connect four IDE devices in your system either Ultra ATA/33 IDE devices or Ultra ATA/66 IDE devices. You will have more flexibility to expand your computer system.

KT7-RAID's built-in HighPoint HPT370 chipset can provide you the capability to support Ultra ATA/100 specifications. It provides two IDE channels (IDE3, IDE4) that also support Ultra ATA/100 specifications, and it allows for four additional IDE devices in your computer system. This means that your computer, in total, can connect up to eight IDE devices (IDE1 ~ IDE4). This allows for maximum expandability for your computer system for future hardware demands. **(KT7-RAID Only)**

KT7/KT7-RAID provides highly flexibility to users building AMD Socket A Athlon™ and Duron™ level systems. It provides the option of 100MHz/100MHz or 100MHz/133MHz CPU and memory bus combinations. You can choose the different combinations and don't need to upgrade many new components to change to this motherboard.

The KT7/KT7-RAID has built-in hardware monitoring functions (you can refer to *Appendix E* for detailed information), they can monitor and protect your computer insuring a safe computing environment. The motherboard can provide high performance for servers and meets the requirements for desktop systems for multimedia in the future.

1-2. Features of KT7A/KT7A-RAID Motherboard

This motherboard is designed for AMD Socket A Athlon™ and Duron™ CPUs. It supports the AMD Socket-A structure, with up to 1.5GB of memory, super I/O, and Green PC functions.

The KT7A/KT7A-RAID uses the VIA Apollo KT133A chipset to make the evolutionary move from PC 100 to PC 133, increasing the speed of the system and memory buses from 100 MHz to 133 MHz. Its' 133 MHz memory interface supports the wide range of PC 133 memory devices now on the market.

The KT7A/KT7A-RAID has a built in Ultra ATA/100 function. This means that it can provides speedier HDD throughput that boosts overall system performance. Ultra ATA/100 is the newest standard for IDE devices. It enhances existing Ultra ATA/100 technology by increasing both performance and data integrity. This new high-speed interface triples the Ultra ATA/33 burst data transfer rate to 100 Mbytes/sec. The result is maximum disc performance using the current PCI local bus environment. Another benefit is, you can connect four IDE devices in your system either Ultra ATA/33 IDE devices, Ultra ATA/66 IDE devices or Ultra ATA/100 IDE devices. You will have more flexibility to expand your computer system.

KT7A-RAID's built-in HighPoint HPT370 chipset can provide you the capability to support Ultra ATA/100 specifications. It provides two IDE channels (IDE3, IDE4) that also support Ultra ATA/100 specifications, and it allows for four additional IDE devices in your computer system. This means that your computer, in total, can connect up to eight IDE devices (IDE1 ~ IDE4). This allows for maximum expandability for your computer system for future hardware demands. **(KT7A-RAID Only)**

KT7A/KT7A-RAID provides highly flexibility to users building AMD Socket A Athlon™ and Duron™ level systems. It provides the option of 100MHz/100MHz, 100MHz/133MHz or 133MHz/133MHz CPU and memory bus combinations. You can choose the different combinations and don't need to upgrade many new components to change to this motherboard.

The KT7A/KT7A-RAID has built-in hardware monitoring functions (you can refer to *Appendix E* for detailed information), they can monitor and protect your computer insuring a safe computing environment. The motherboard can provide high performance for servers and meets the requirements for desktop systems for multimedia in the future.

1-3. Specifications

1. CPU

For KT7/KT7-RAID:

- Supports AMD Duron™ 600MHz ~ 850MHz or future Socket A processors based on 200MHz (100MHz Double Data Rate)
- Supports AMD Athlon™ 700MHz ~ 1.2GHz or future Socket A processors based on 200MHz (100MHz Double Data Rate)
- Supports 200MHz Alpha EV6 bus for the AMD Athlon™ & Duron™ processors

For KT7A/KT7A-RAID:

- Supports AMD Duron™ 600MHz ~ 850MHz or future Socket A processors based on 200MHz (100MHz Double Data Rate)
- Supports AMD Athlon™ 700MHz ~ 1.2GHz or future Socket A processors based on 200MHz/266MHz (100MHz/133MHz Double Data Rate)
- Supports 200MHz/266MHz Alpha EV6 bus for the AMD Athlon™ & Duron™ processors

2. Chipset

For KT7/KT7-RAID:

■ VIA Apollo KT133 chipset (VT8363 and VT82C686A):

- Supports Ultra DMA/33 and Ultra DMA/66 IDE protocol
- Supports Advanced Configuration and Power Management Interface (ACPI)
- Accelerated Graphics Port connector supports AGP 2x (3.3V) and 4x (1.5V) mode (Sideband) device
- Supports 100MHz/100MHz, 100MHz/133MHz memory bus settings

For KT7A/KT7A-RAID:

■ VIA Apollo KT133A chipset (VT8363A and VT82C686B):

- Supports Ultra DMA/33, Ultra DMA/66 and Ultra DMA/100 IDE protocol
- Supports Advanced Configuration and Power Management Interface (ACPI)
- Accelerated Graphics Port connector supports AGP 2x (3.3V) and 4x (1.5V) mode (Sideband) device
- Supports 100MHz/100MHz, 100MHz/133MHz and 133MHz/133MHz memory bus settings

■ HighPoint Technologies, Inc. HPT 370 chipset (KT7-RAID/KT7A-RAID Only):

- Supports ATA/100 specifications
- Automatically fine tunes each IDE/ATAPI device to the best performance
- Concurrent PIO and bus master access (ATA port accessible during DMA transfer)
- Detailed specifications:
 - Ultra DMA 100MB/sec data transfer rate
 - RAID 0 (stripping mode for boosting performance)
 - RAID 1 (mirroring mode for data security)
 - RAID 0 + 1 (stripping and mirroring)
 - Two independent ATA channels
 - 256 Byte FIFO per ATA channels
 - Compliant with Plug & Play
 - Up to 4 IDE devices supported
- Drive Modes Support
 - Ultra 5/4/3/2/1/0
 - PIO 4/3/2/1/0
 - DMA 2/1/0
- BIOS Support
 - Friendly UI for RAID functions settings
 - Auto detects and supports Ultra Mode(ATA/EIDE) transfers
 - Recognizes drives up to 128 GB
- Operating System Supports
 - Microsoft® DOS® 5.X and above
 - Microsoft® Windows® 95/98
 - Microsoft® Windows® 2000
 - Microsoft® Windows® NT4.0
 - ABIT Gentus™ 3.0A or later version (Linux)

3. Memory (System Memory)

- Three 168-pin DIMM slots support unbuffered SDRAM modules
- Supports up to 1.5GB MAX. (8, 16, 32, 64, 128, 256 and 512MB SDRAM)

4. System BIOS

- SOFT MENU™ III, can easily set the processor parameters
- Award Plug and Play BIOS supports APM and DMI
- Write-Protect Anti-Virus function by AWARD BIOS

5. Multi I/O Functions

For KT7/KT7-RAID:

- Two channels (IDE1 & IDE2) of Bus Master IDE ports supporting up to four Ultra DMA 33/66 devices. **(KT7 Only)**

And two channels (IDE3 & IDE4) of Bus Master IDE ports supporting up to four Ultra DMA 33/66/100 specifications HDD devices **(KT7-RAID Only)**

For KT7A/KT7A-RAID:

- Two channels (IDE1 & IDE2) of Bus Master IDE ports supporting up to four Ultra DMA 33/66/100 devices. **(KT7A Only)**

And two channels (IDE3 & IDE4) of Bus Master IDE ports supporting up to four Ultra DMA 33/66/100 specifications HDD devices **(KT7A-RAID Only)**

For KT7A/KT7-RAID/KT7A/KT7A-RAID:

- PS/2 keyboard and PS/2 mouse connectors
- One floppy port connector (up to 2.88MB)
- One parallel port connector (EPP/ECP)
- Two serial ports connectors
- Two USB connectors
- One USB header for two extra USB channels

6. Miscellaneous

- ATX form factor
- One AGP slot, six PCI slots and one ISA slots
- Built-in Wake on LAN header
- Built-in IrDA TX/RX header
- Built-in Wake On Ring header
- Built-in two SM-Bus headers
- Hardware monitoring : Included fan speed, voltages, CPU and system environment temperature
- Board size: 305 * 230mm

* Ultra ATA/100 device connecting cable is the same as the Ultra ATA/66 device connecting cable.

* PCI slot 5 shares IRQ signals with the HPT370 IDE controller (supports Ultra ATA/100). The driver for HPT 370 IDE controller supports IRQ sharing with other PCI devices. But if you install a PCI card that doesn't allow IRQ sharing with other devices into PCI slot 5, you may encounter some problems. Furthermore, if your Operating System doesn't allow peripheral devices to share

IRQ signals with each other, such as Windows® NT for example, you can't install a PCI card into PCI slot 5. (KT7-RAID & KT7A-RAID Only)

- * HPT 370 IDE controller is designed to support high-speed and high performance mass storage devices. Thus we suggest that you don't connect non-disk devices that use ATA/ATAPI interfaces, such as CD-ROM to HPT 370 IDE connector (IDE3 & IDE4). (KT7-RAID & KT7A-RAID Only)
- * The memory module do not supports ECC and Registered DIMM.
- * Supports Wake On LAN and Wake On Ring, but your ATX power supply +5V standby power must be able to provide at least a 720mA current capacity. Otherwise, the functions may not work normally.
- * Due to the PCI, memory, chipset and processor specifications, we do not guaranteed over specification operation of frequency.
- * Specifications and information contained in this manual are subject to change without notice.

Note

All brand names and trademarks are the property of their respective owners.

1-4. Item Checklist

Check that your package is complete. If you discover any damaged or missing items, please contact your retailer or dealer.

- One ABIT Motherboard
- One 80-wire/40-pin ribbon cable for master and slave Ultra DMA/100, Ultra DMA/66 or Ultra DMA/33 IDE devices **(KT7/KT7A Only)**
- Two 80-wire/40-pin ribbon cable for master and slave Ultra DMA/100, Ultra DMA/66 or Ultra DMA/33 IDE devices **(KT7-RAID/KT7A-RAID Only)**
- One ribbon cable for 5.25" and 3.5" floppy disk devices
- One compact disc for support drivers and utilities
- One user's manual for the motherboard
- One USB cable

1-5. Layout Diagram for KT7/KT7-RAID

* Red mark indicates pin 1 location.

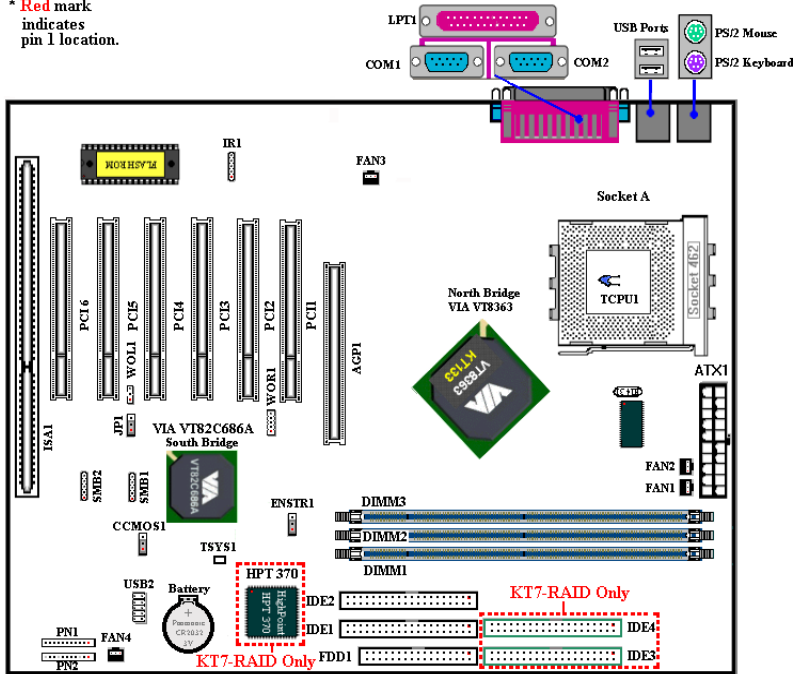

Figure 1-1. KT7/KT7-RAID Motherboard component location

1-6. Layout Diagram for KT7A/KT7A-RAID

* Red mark indicates pin 1 location.

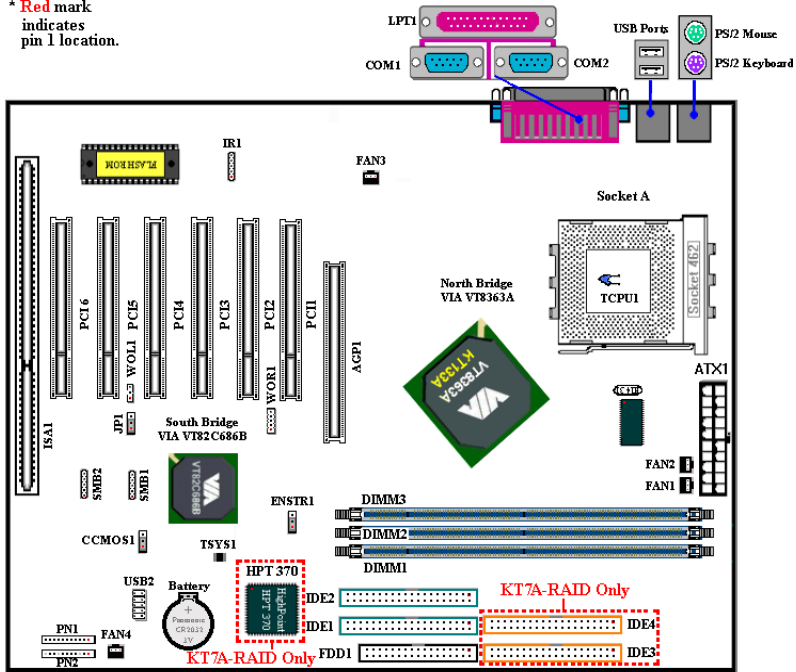

Figure 1-2. KT7A/KT7A-RAID Motherboard component location

1-7. The System Block Diagram for KT7/KT7-RAID

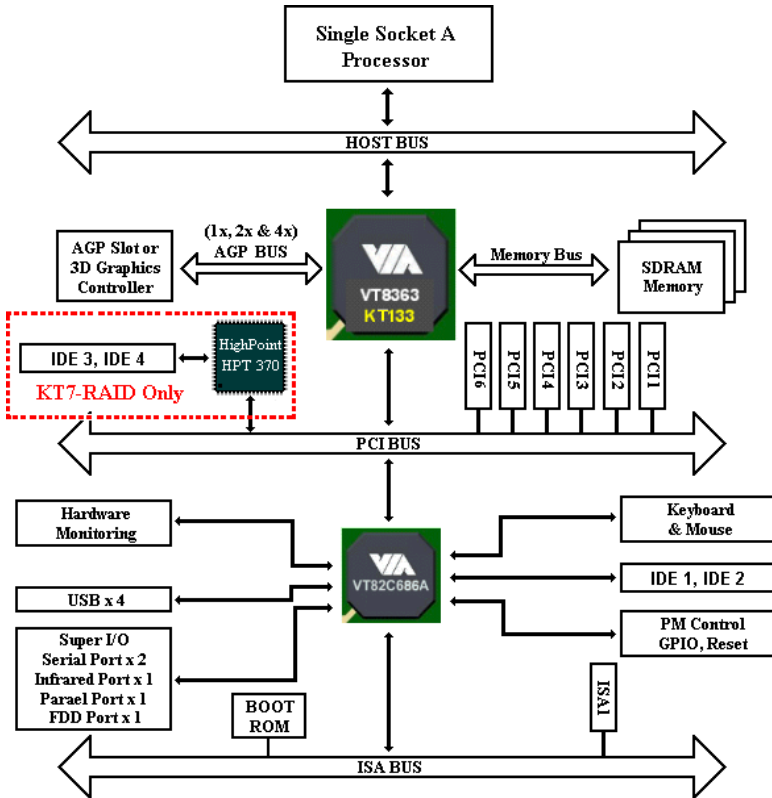

Figure 1-3. System diagram of the KT7/KT7-RAID

1-8. The System Block Diagram for KT7A/KT7A-RAID

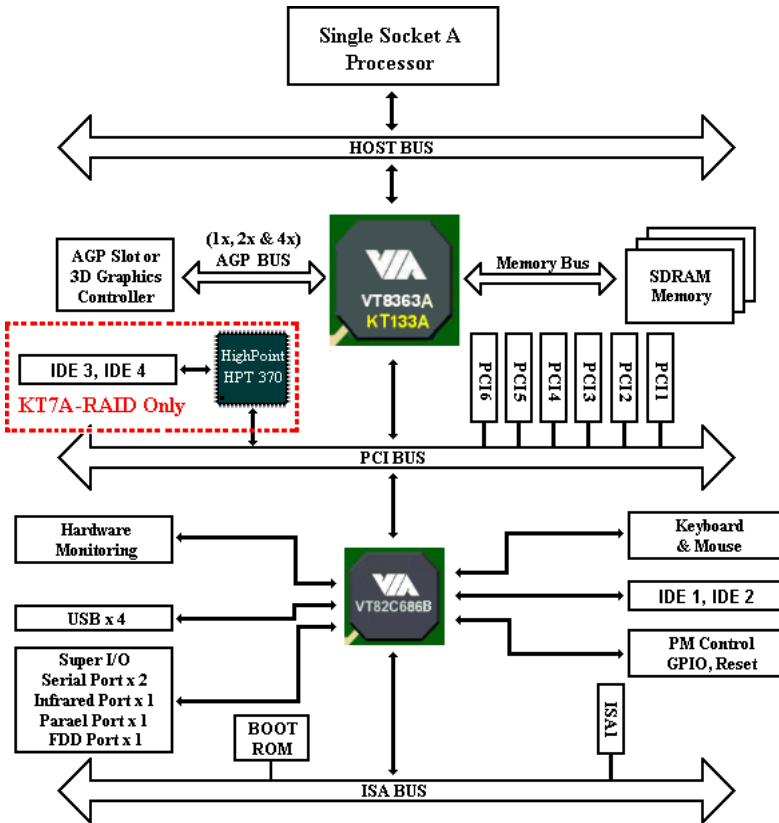

Figure 1-4. System diagram of the KT7A/KT7A-RAID

Chapter 2. Installing the Motherboard

This K T7/K T7-RAID/K T7A/K T7A-RAID motherboard not only provides all standard equipment for classic personal computers, but also provides great flexibility for meeting future upgrade demands. This chapter will introduce step by step all of the standard equipment and will also present, as completely as possible, future upgrade capabilities. This motherboard is able to support all AMD Socket A Athlon™ and Duron™ processors now on the market. (For details, see specifications in Chapter 1.)

This chapter is organized according the following features:

- 2-1 Installing the Motherboard to the Chassis
- 2-2 Installation of the AMD Socket A Athlon™ and Duron™ CPU
- 2-3 Installing System Memory
- 2-4 Connectors, Headers and Switches



Before Proceeding with the Installation



Before you install or unplug any connectors or add-on cards, please remember to turn the ATX power supply switch off (fully turn the +5V standby power off), or take the power cord off. Otherwise, you may cause the motherboard components or add-on cards to malfunction or be damaged.



User Friendly Instructions

Please read our instructions carefully and follow them step-by-step. Our objective is to enable the novice computer user to perform the installation by himself. We have attempted to write this document in a very clear, concise and descriptive manner to help overcome any obstacles you may face during installation.

2-1. Installing the Motherboard to the Chassis

Most computer chassis will have a base on which there will be many mounting holes that allows the motherboard to be securely attached and at the same time, prevents short circuits. There are two ways to attach the motherboard to the base of chassis:

- with studs
- or with spacers

Please refer to figure 2-1, which shows the studs and spacers. There may be several types, but all look like the figures below:

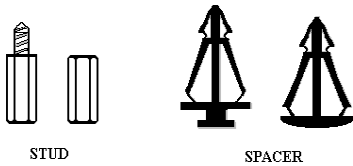

Figure 2-1. The outline of stub and spacer

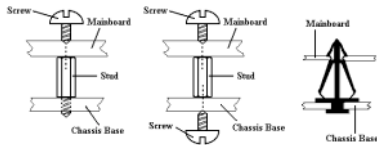

Figure 2-2. The way we fixed the motherboard

In principle, the best way to attach the motherboard is with studs. Only if you are unable to do this should you attach the board with spacers. Take a careful look at the motherboard and you will see many mounting holes on it. Line these holes up with the mounting holes on the base. If the holes line up and there are screw holes this means you can attach the motherboard with studs. If the holes line up and there are only slots, this means you can only attach the motherboard with spacers. Take the tip of the spacers and insert them into the slots.

After doing this to all the slots, you can slide the motherboard into position aligned with the slots. After the motherboard has been positioned, check to make sure everything is OK before putting the casing back on.

Figure 2-2 shows you the way to affix the motherboard using studs or spacers.

Note

If the motherboard has mounting holes, but they don't line up with the holes on the base and there are no slots to attach the spacers, don't worry, you can still attach the spacers to the mounting holes. Just cut the bottom portion of spacers (the spacer they may be a little hard to cut, so be careful with your hands). In this way you can still attach the motherboard to the base without worrying about short circuits. Sometimes you may need to use the plastic springs to isolate the screw from the motherboard PCB surface, because the circuit wire may be near by the hole. Be careful, don't let the screw contact any the printed circuit wire or parts on the PCB that are near the fixing hole, otherwise it may damage the board or cause board malfunctioning.

2-2. Installation of the AMD Athlon™ and Duron™ CPU

Note

- Installing a heatsink and cooling fan is necessary for heat to dissipate from your processor. Failing to install these items may result in overheating and processor damage.
- The AMD Socket A processor will produce a lot of heat while operating, so you need to use a large heat sink that is especially designed for the AMD socket A processor. Otherwise, it may result in overheating and processor damage.
- If your processor fan and its power cable are not installed properly, never plug the ATX power cable into the motherboard. This can prevent possible processor damage.
- Please refer to your processor installation manual or other documentation with your processor for detailed installation instructions.

The AMD Socket A Athlon™ and Duron™ processor installation is easy, like Socket 7 Pentium® processors before. Because it uses the “Socket A” ZIF (Zero Insertion Force) socket, you can easily fix the processor firmly into position. Figure 2-3 shows you what the socket A looks like, and how to open the lever. The socket A has more pins than the socket 7. Therefore, a Pentium level processor cannot be inserted into a socket A.

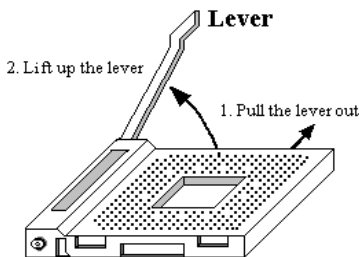

Figure 2-3. Socket A and open its lever

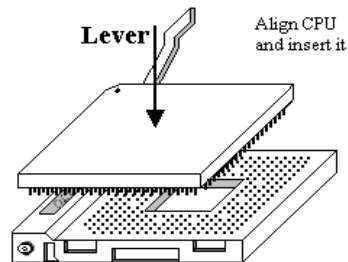
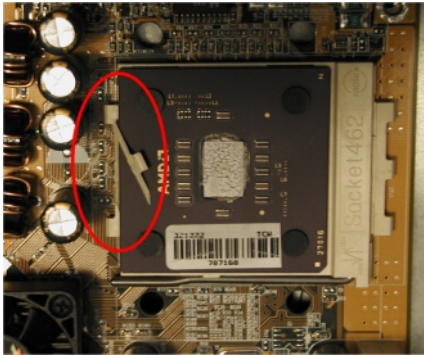

Figure 2-4. Install the CPU into socket A

When you raise the lever, you have to loosen the socket lock. Please raise the lever to the end, and prepare to insert the processor. Next, you need to align the processor pin 1 to the socket pin 1. If you put it in the wrong direction, you will not be able to insert the processor easily, and processor pins will not fully go into the socket. If this is the case, please change the direction, until it easily and fully inserts into the socket A. See Figure 2-4. At the same time check the processor temperature detection thermistor height (if your motherboard has this component), then you can slowly insert the processor into the Socket A. Finally, you need to check that the processor edge and the Socket A edge is parallel. It should be parallel and not tilted. When you finish the above, push the lever down to its original position, you should feel the lever lock the socket A. You have then finished the processor installation.

Heatsink Installation Hints

Because the processor will produce a lot of heat while operating, we suggest you use a heatsink approved by AMD to be safe and to keep the processor temperature within normal operation temperatures. The heatsink will be large and heavy, so the fixing plate has a strong tension. When you install the heatsink on to the processor and its socket, you have to very carefully fix the fixing plate to the processor socket hook on both sides. If you do not pay attention to this, you may make the fixing plate scratch the PCB surface and cause circuit damage, break socket hooks or damage the die on the top of processor.



Please follow the sequence mentioned below, **Do Not** inverse the sequence. Otherwise, you may have a situation like the photo on the left. Because of the design of the CPU socket, the left side hooks are not as strong as the right side hooks. If you follow our suggestions you will prevent your processor and socket from damage.

Note

Considering the chassis structure problem, please always take off the motherboard from chassis, before adding or removing a heatsink kit.

The proper procedure to install the heatsink kit:



First, install the processor into the processor socket.

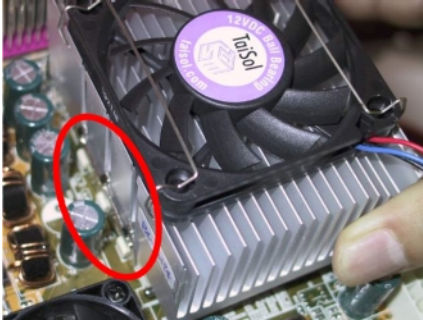

Insert the heatsink left side fix plate into the processor socket left side fix hooks. Make sure the fit is very tight. Check the photo on the left.



Insert a flat screwdriver into the middle slot of the right side fix plate and push down. Then you can push the fix plate over the socket hooks on the right side. Check the photo on the left.

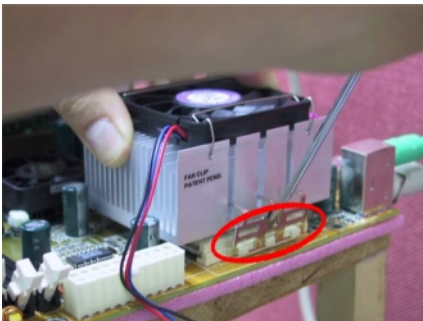

Check the photo on the left. You have finished the heatsink installation. Now hold the whole heatsink and slightly shake it, make sure the bottom right side of the heatsink does not contact the right side of the Socket (see bottom picture). Otherwise, the processor die does not have proper contact with the heatsink. This situation may cause processor damage. Remember to install the heatsink fan

power cable to the CPU fan header on the motherboard.

Now you can reinstall the motherboard back into the chassis.

When all above procedures done, you can connect the ATX power cable to the motherboard.

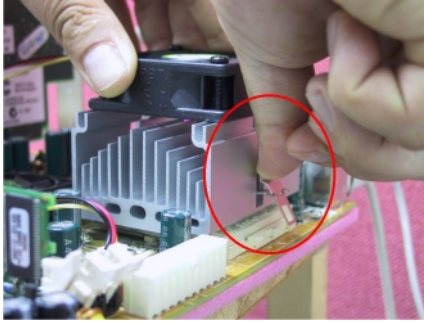

If you have different types of heatsink kit, please refer to the manual that came with the heatsink kit. The left photo shows another type of heatsink fix plate design. The install sequences are still the same, from right side to left side. Just remember that.

We strongly recommend you to buy a heatsink with three holes in the fix plate. This will provide the best

stability and won't cause the Socket fix hooks to be broken or damaged.



The left photo shows the bottom right side of the heatsink in contact with the right side of the Socket. In this situation, the processor die does not properly contact the heatsink. If you start the computer at this moment, it will immediately cause the processor damage. Always check this place when you finish the heatsink installation.

2-3. Installing System Memory

This motherboard provides three 168-pin DIMM sites for memory expansion. The DIMM sockets support 1Mx64 (8MB), 2Mx64 (16MB), 4Mx64 (32MB), 8Mx64 (64MB), 16Mx64 (128MB), 32Mx64 (256MB) and 64Mx64 (512MB) or double sided DIMM modules. Minimum memory size is 8MB and maximum memory size is 1.5GB SDRAM. There are three memory module sockets on the system board. (Total six banks)

In order to create a memory array, certain rules must be followed. The following set of rules allows for optimum configurations.

- The memory array is 64 or 72 bits wide. (depending on with or without parity)
- Those modules should be populated in DIMM1 to DIMM3 by orders.
- Supports single and double density DIMMS.

Table 2-1. Valid Memory Configurations

Bank	Memory Module	Total Memory
Bank 0, 1 (DIMM1)	8MB, 16MB, 32MB, 64MB, 128MB, 256MB, 512MB	8MB ~ 512MB
Bank 2, 3 (DIMM2)	8MB, 16MB, 32MB, 64MB, 128MB, 256MB, 512MB	8MB ~ 512MB
Bank 4, 5 (DIMM3)	8MB, 16MB, 32MB, 64MB, 128MB, 256MB, 512MB	8MB ~ 512MB
Total System Memory		8MB ~ 1.5GB

Generally, installing SDRAM modules to your motherboard is an easy thing to do. You can refer to Figure 2-5 to see what a 168-pin PC100 & PC133 SDRAM module looks like.

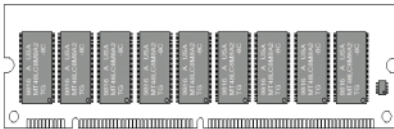

Figure 2-5 PC100/PC133 Module and Component Mark

Unlike installing SIMMs, DIMMs may be "snapped" directly into the socket. Note: Certain DIMM sockets have minor physical differences. If your module doesn't seem to fit, please do not force it into the socket as you may damaged your memory module or DIMM socket.

The following procedure will show you how to install a DIMM module into a DIMM socket.

- Step 1.** Before you install the memory module, please place the computer power switch in the *off* position and disconnect the AC power cord from your computer.
- Step 2.** Remove the computer's chassis cover.

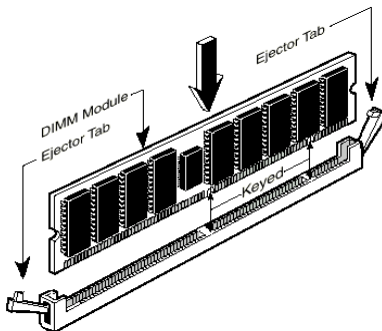

Figure 2-6. Memory module installation

Step 3. Before touching any electronic components, make sure you first touch an unpainted, grounded metal object to discharge any static electricity stored on your clothing or body.

Step 4. Locate your computer's 168-pin memory expansion DIMM socket.

Step 5. Insert the DIMM module into the expansion socket as shown in the illustration. Note how the module is keyed to the socket. You can refer to Figure 2-6 for the details. *This insures*

the DIMM module will be plugged into the socket in one way only. Firmly press the DIMM module into DIMM socket, making certain the module is completely seated in the DIMM socket.

Step 6. Once the DIMM module has been installed, the installation is complete and the computer's cover can be replaced. Or you can continue to install other devices and add-on cards that are mentioned in the following section.

Note

When you install a DIMM module fully into the DIMM socket, the eject tab should be locked into the DIMM module very firmly and fit into its indentation on the both sides.

It is difficult to differentiate between the PC100 and PC133 SDRAM modules from the exterior. The only way you can identify them is to look at the sticker on the RAM module. The sticker will tell you which kind of structure module the RAM is.

2-4. Connectors, Headers and Switches

Inside the case of any computer several cables and plugs have to be connected. These cables and plugs are usually connected one-by-one to connectors located on the motherboard. You need to carefully pay attention to any connection orientation the cables may have and, if any, notice the position of the first pin of the connector. In the explanations that follow, we will describe the significance of the first pin.

We will show you all of the connectors, headers and switches here, and tell you how to connect them. Please pay attention and read the entire section for necessary information before attempting to finish all of the hardware installation inside the computer chassis.

Figure 2-7A/2-7B (for KT7/KT7-RAID) and Figure 2-7C/2-7D (for KT7A/KT7A-RAID) shows you all of the connectors and headers that we'll discuss in the next section, you can use this diagram to visually locate each connector and header we describe.

All connectors, headers and switches mentioned here, will depend on your system configuration. Some features you may (or may not) have and need to connect or configure depending on the peripheral. If your system doesn't have such add-on cards or switches you can ignore some special feature connectors.

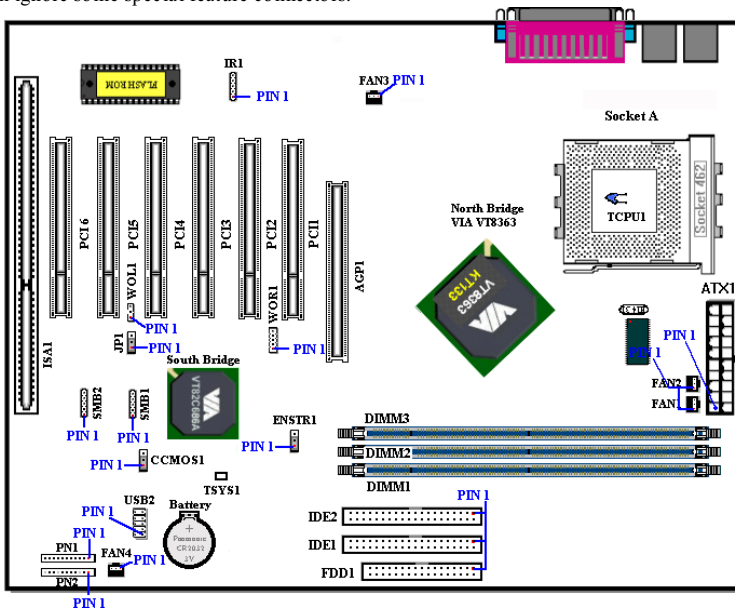

Figure 2-7A. All Connectors and Headers for the KT7

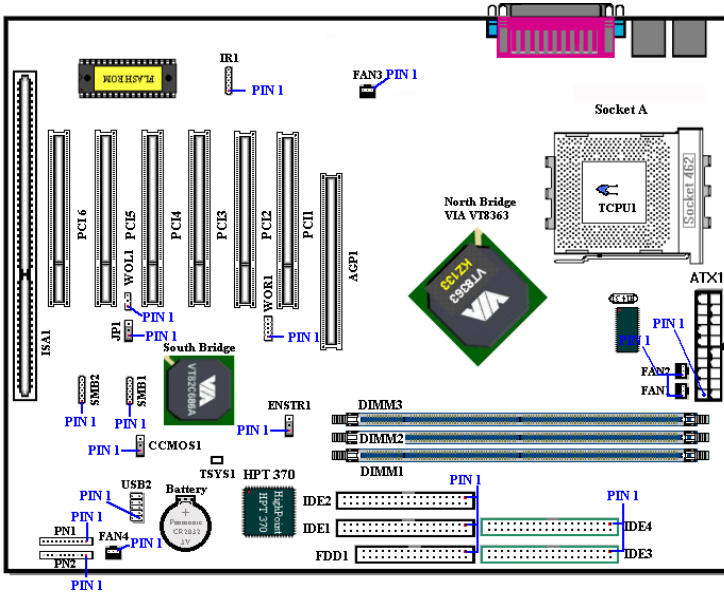

Figure 2-7B. All Connectors and Headers for the KT7-RAID

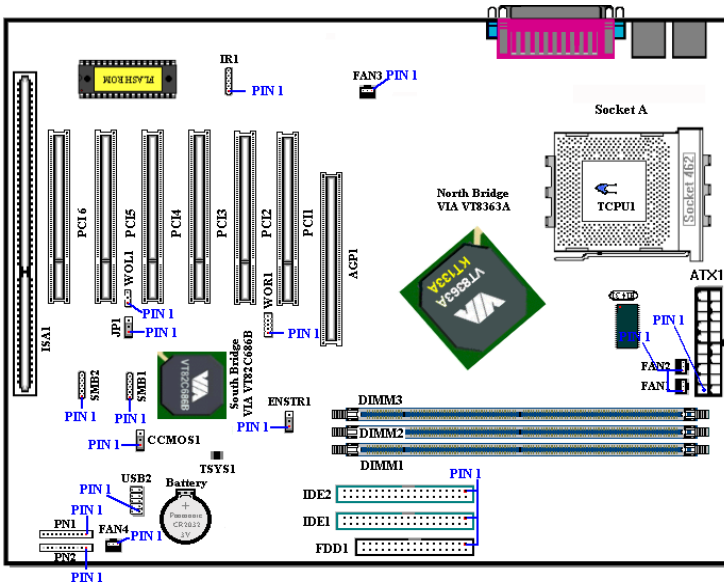

Figure 2-7C. All Connectors and Headers for the KT7A

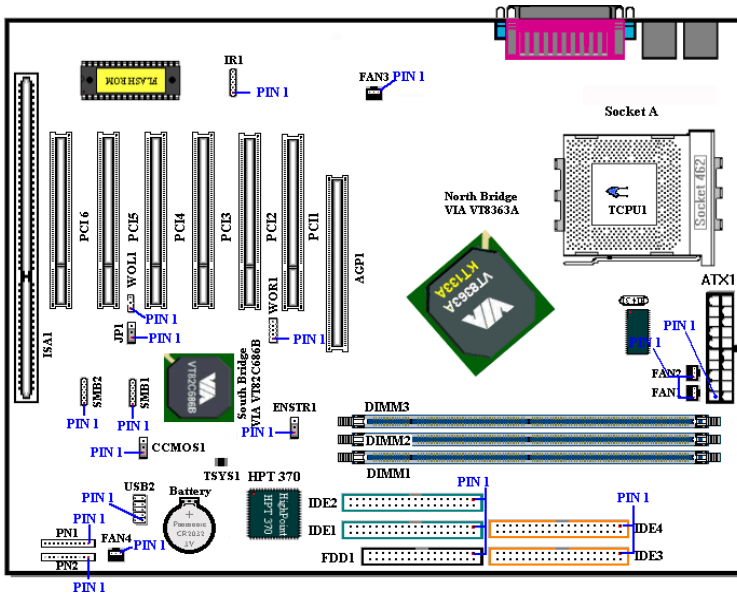
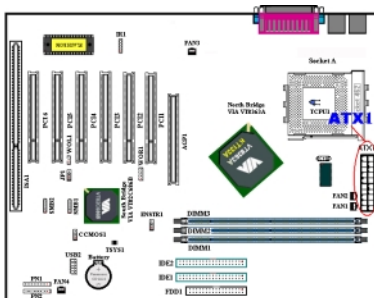

Figure 2-7D. All Connectors and Headers for the KT7A-RAID

First, Let's see the headers that KT7/KT7-RAID/KT7A/KT7A-RAID uses, and what their functions are. We will use the KT7A & KT7A-RAID as sample to show you all the connectors and headers. Because the KT7 & KT7-RAID are all likes them, just use different chipsets.

(1) ATX1: ATX Power Input Connector



Attach the connector from the power supply to the ATX1 connector here. Remember you have to push the connector from the ATX power supply firmly to the end with the ATX1 connector, insuring that you have a good connection.

Note: Watch the pin position and the orientation.

Caution

If the power supply connectors are not properly attached to the ATX power supply, the power supply or add-on cards may be damaged.

(2) FAN1, FAN2, FAN3 & FAN4 header

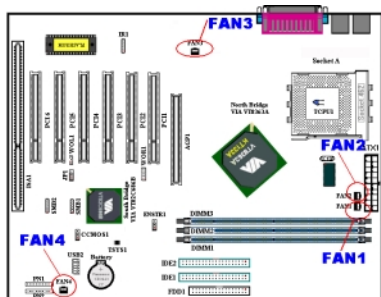

Attach the connector from the individual CPU fan to the header named FAN1 or FAN2 (or both if you use the dual fan cooling system), connector from the chassis fan to the header FAN4 and attach the connector from the power fan to FAN3 header.

You must attach the CPU fan to the processor, or your processor will work abnormally or may be damaged by overheating. Also, if you want the computer case's internal temperature to be kept steady and not too high, you had better connect the chassis fan to reach this goal.

Note: Watch the pin position and the orientation

(3) IRI1: IR Header (Infrared)

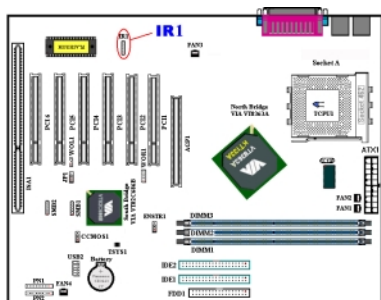

There is a specific orientation for pins 1 through 5, attach the connector from the IR KIT or IR device to the IRI1 header (left row only). This motherboard supports standard IR transfer rates.

Note: Watch the pin position and the orientation

Pin Number	Name or significance of signal	Pin Number	Name or significance of signal
1	+5V	4	Ground
2	No Connection	5	IR_TX
3	IR_RX		

(4) WOR1: Wake On Ring Header

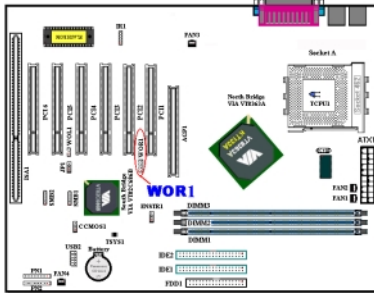

If you have an internal modem adapter that supports this feature, then you can connect the specific cable from the internal modem adapter to this header. This feature lets you wake up your computer via remote control through the modem.

Note: Watch the pin position and the orientation

(5) WOL1: Wake on LAN Header

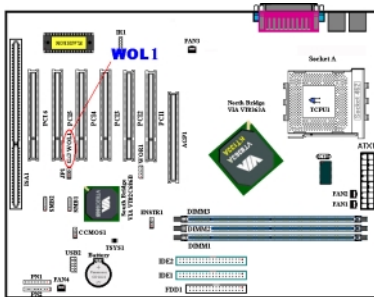

If you have a network adapter that supports this feature, then you can connect the specific cable from the network adapter to this header. This feature lets you wake up your computer via remote control through a local area network. You may need a specific utility to control the wake up event, like using the PCnet Magic Packet utility or other similar utilities.

There are three types of WOL, “Remote Wake-Up high (RWU-high)”, “Remote Wake-Up low (RWU-low)”, and “Power Management Event (PME)”. This motherboard supports the type of “**Remote Wake-Up low (RWU-low)**” only.

Note: Watch the pin position and the orientation

(6) SMB1 & SMB2 header: System Management Bus Connector

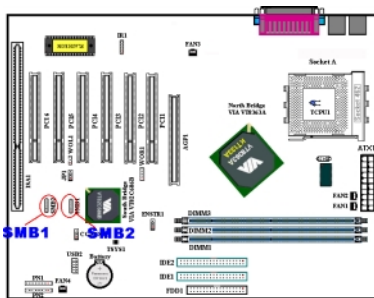

These connectors are reserved for the system management bus (SM Bus). The SM Bus is a specific implementation of an I²C bus. I²C is a multi-master bus which means that multiple chips can be connected to the same bus and each one can act as a master by initiating a data transfer. If more than one master simultaneously tries to control the bus, an arbitration procedure decides which

master gets priority. You can connect the ABIT Postman to this header, or other devices which utilizes the SM Bus.

Note: Watch the pin position and the orientation

(7) TCPUI & TSY51: Temperature Thermistor

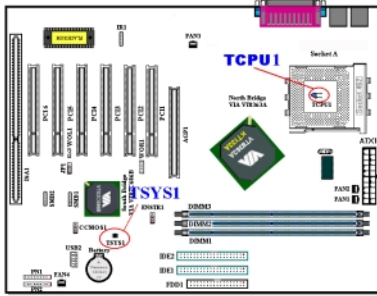

The TCPUI is used to detect the CPU temperature. The TSY51 is used to detect the system environment temperature. You can see the readings in the BIOS or the VIA hardware monitoring screen.

(8) USB2 Headers: Additional USB Plugs Header

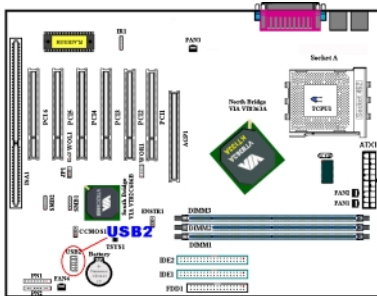

This header is for connecting the additional USB port plugs. You can use the special USB port expansion cable (optional). It provides two additional USB plugs. These USB plugs can be fixed on the back panel.

Pin number	Name or significance of signal
1	Key Pin
2	NC
3	VCC0
4	VCC1
5	Data0 -
6	Data1 -
7	Data0 +
8	Data1 +
9	Ground
10	Ground

(9) CCMOS1: CMOS Discharge Jumper

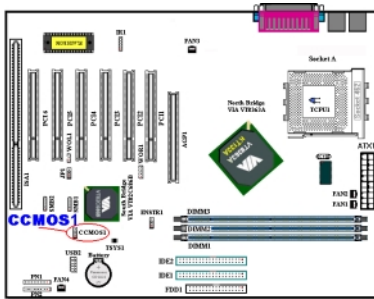

Jumper CCMOS1 discharge CMOS memory. When you install the motherboard, make sure this jumper is set for normal operation (pin 1 and 2 shorted). See figure 2-8.

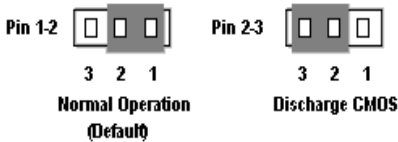
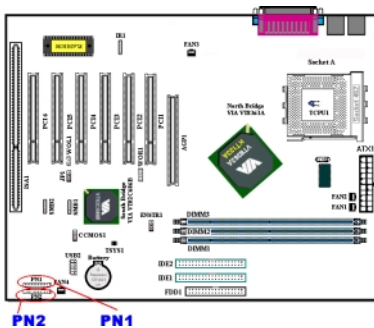

Figure 2-8. CCMOS1 jumper setting

Note

Before you clear the CMOS, you have to first turn the power off (including the +5V standby power). Otherwise, your system may work abnormally or malfunction.

(10) PN1 and PN2 Headers



PN1 and PN2 are for switches and indicators for the chassis's front panel, there are several functions that come from these two headers. You have to watch the pin position and the orientation, or you may cause system malfunctions. Figure 2-9 shows you the PN1 and PN2 functions of the pins.

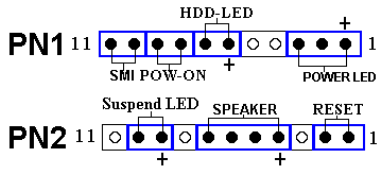

Figure 2-9. The definition of PN1 and PN2 pins

PN1 (Pin 1-2-3): Power LED Headers

There is a specific orientation for pins 1 through 3. Insert the three-threaded power LED cable to pins 1~3. Check to make sure the correct pins go to the correct connectors on the motherboard. If you install them in the wrong direction, the power LED light will not illuminate correctly.

Note: Watch the power LED pin position and orientation.

PN1 (Pin 6-7): HDD LED Header

Attach the cable from the case's front panel HDD LED to this header. If you install it in the wrong direction, the LED light will not illuminate correctly.

Note: Watch the HDD LED pin position and the orientation.

PN1 (Pin 8-9): Power on Switch Header

Attach the cable from the case's front panel power switch to this header.

PN1 (Pin 10-11): Hardware Suspend Switch (SMI Switch) Header

Attach the cable from the case's front panel suspend switch (if there is one) to this header. Use this switch to enable/disable the power management function by hardware.

PN2 (Pin 1-2): Hardware Reset Switch Header

Attach the cable from the case's front panel Reset switch to this header. Press and hold the reset button for at least one second to reset the system.

PN2 (Pin 4-5-6-7): Speaker Header

Attach the cable from the system speaker to this header.

PN2 (Pin 9-10): Suspend LED Header

Insert the two-threaded suspend LED cable into pin 9 and pin 10. If you install it in the wrong direction, the LED light will not illuminate correctly.

Note: Watch the Suspend LED pin position and the orientation. For pin count-name list for PN1 and PN2, please refer to table 2-2.

For the PN1 and PN2 pin’s count-name list, please refer to table 2-2.

Table 2-2. PN1 and PN2 pin count name list

PIN Name		Significance of signal	PIN Name		Significance of signal
PN1	PIN 1	+5VDC	PN2	PIN 1	Ground
	PIN 2	No connection		PIN 2	Reset input
	PIN 3	Ground		PIN 3	No connection
	PIN 4	No connection		PIN 4	+5VDC
	PIN 5	No connection		PIN 5	Ground
	PIN6	LED power		PIN6	Ground
	PIN 7	HDD active		PIN 7	Speaker data
	PIN 8	Ground		PIN 8	No connection
	PIN 9	Power On/O ff signal		PIN 9	LED power
	PIN 10	Ground		PIN 10	Suspend active
	PIN 11	Suspend signal		PIN 11	No connection

Let’s now see the I/O connectors that KT7/KT7-RAID/KT7A/KT7A-RAID uses, and what their functions are.

(11) ENSTR1 Header

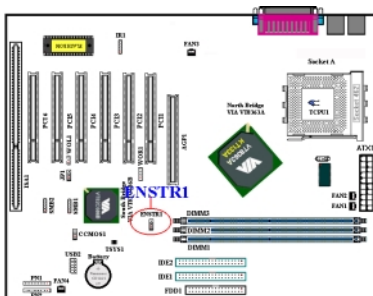

This header lets you enable or disable the suspend to RAM (STR) function. With Pin 1 and pin2 shorted, you enable the STR function (default setting), With pin 2 and pin 3 shorted, you disable the STR function.

Please refer to the BIOS ACPI Suspend Type item to make correct setting.

(12) FDD1 Connector

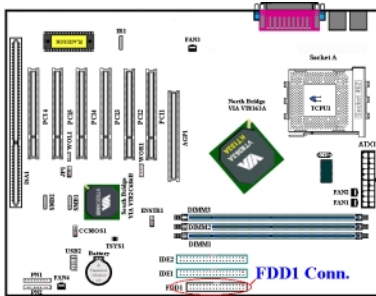

This 34-pin connector is called the “*floppy disk drive connector*”. You can connect a 360K, 5.25”, 1.2M, 5.25”, 720K, 3.5”, 1.44M, 3.5” or 2.88M, 3.5” floppy disk drive, you can even connect a 3 Mode floppy disk drive (it’s a 3 1/2” drive used in Japanese computer systems).

A floppy disk drive ribbon cable has 34 wires and two connectors to provide the connection of two floppy disk drives. After connecting the single end to the FDD1, connect the two connectors on the other end to the floppy disk drives. In general, people only install one floppy disk drive on their computer system.

Note

A red mark on a wire typically designates the location of pin 1. You need to align the wire pin 1 to the FDD1 connector pin 1, then insert the wire connector into the FDD1 connector.

(13) IDE1 and IDE2 Connectors

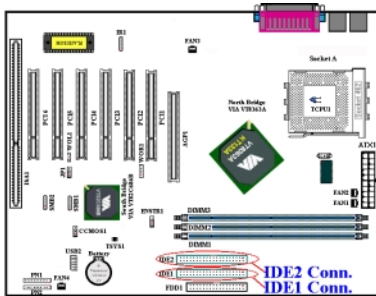

An IDE hard disk drive ribbon cable has 40 wires and two connectors to provide a connection for two IDE hard disk drives. After connecting the single end to the IDE1 (or IDE2), connect the two connectors on the other end to the IDE hard disk drives (or CD-ROM drive, LS-120, etc.).

Before you install a hard disk, there are some things you need to be aware of:

- ◆ “Primary” refers to the first connector on the motherboard, that is, the IDE1 connector on the motherboard.
- ◆ “Secondary” refers to the second connector on the motherboard, that is, the IDE2 connector on the motherboard.

- ◆ Two hard disks can be connected to each cable:

The first HDD is referred to as the “Master”, the second HDD is referred to as the “Slave”.

- ◆ For performance issues, we strongly suggest you don’t install a CD-ROM drive on the same IDE channel as a hard disk. Otherwise, the system performance on this channel may drop. (how much depends on your CD-ROM drive performance)

Note

- The Master or Slave status of the hard disk drive is set on the hard disk itself. Please refer to the hard disk drive user’s manual.
- A red mark on a wire typically designates the location of pin 1. You need to align the wire pin 1 to the IDE connector pin 1, then insert the wire connector into the IDE connector.

(14) IDE3 and IDE4 Connectors

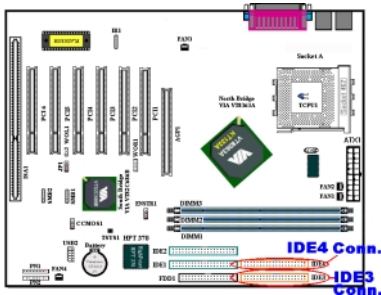

KT7-RAID’s & KT7A-RAID’s built-in HighPoint HPT370 chipset can provide you the capability to support Ultra ATA/100 specifications. It provides two IDE channels (IDE3, IDE4) that also support Ultra ATA/100 specifications, and it allows for four additional IDE devices in your computer system.

NOTE

To connect Ultra ATA/100 devices on IDE3 or IDE4, an Ultra ATA/66 cable is required.

There are four requirements for attaining Ultra ATA/66 and Ultra ATA/100:

- * The drive must support Ultra ATA/66 or Ultra ATA/100.
- * The motherboard and system BIOS (or an add-in controller) must support Ultra ATA/66 or Ultra ATA/100.

- * The operating system must support Direct Memory Access (DMA); Microsoft® Windows® 98 and Windows® 95B (OSR2) support DMA.
- * The cable must be an 80-pin conductor. The length should not exceed 18 inches. If all of the above requirements are met, you can enjoy the Ultra ATA/66 and ATA-100 features of your computer system.

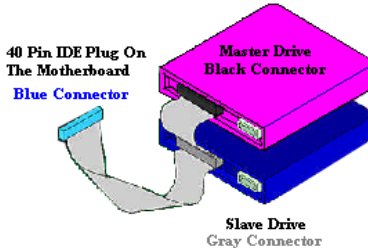

Figure 2-10. How to connect an Ultra ATA/66 Cable to the Motherboard

thus assuring positive mating (pin #1 to pin #1).

- The red line on the cable should be aligned with pin #1. On the drives this will result in the red line facing the power connector. Attach the BLUE connector to the appropriate 40 pin IDE plug on the motherboard.
- Attach the BLACK connector to the mating plug on the master hard drive. Attach the GREY connector to the mating plug on the slave drive (secondary hard drive, CD-ROM, or tape drive). Please refer figure 2-10.

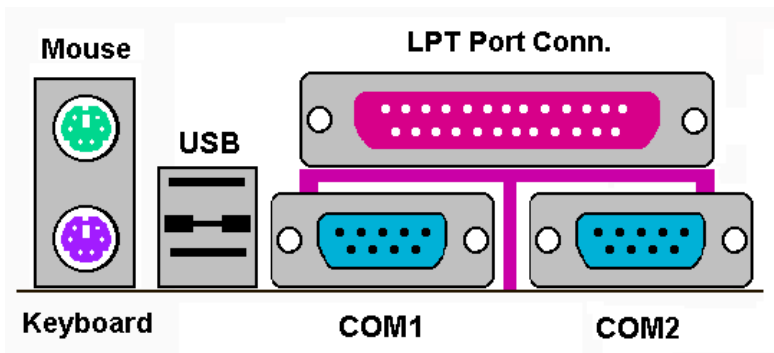

Figure 2-11. KT7/KT7-RAID/KT7A/KT7A-RAID back panel connectors

Figure 2-11 shows the KT7/KT7-RAID/KT7A/KT7A-RAID back panel connectors, these connectors are for connection to outside devices to the motherboard. We will describe which devices will attach to these connectors below.

PS/2 Keyboard Connector



you use a PS/2 keyboard for best compatibility.

Attach a PS/2 keyboard connector to this 6-pin Din-connector. If you use an AT keyboard, you can go to a computer store to purchase an AT to ATX converter adapter, then you can connect your AT keyboard to this connector. We suggest

PS/2 Mouse Connector



Attach a PS/2 mouse to this 6-pin Din-connector.

USB Port Connectors

This motherboard provides two USB ports. Attach the USB connector from the individual device to these connectors.

You can attach USB devices such as a, scanner, digital speakers, monitor, mouse, keyboard, hub, digital camera, joystick etc. to one of each USB connector. You must make sure your operating system supports this feature and you may need to install an additional driver for individual devices. In Please refer to your device user's manual for detailed information.

Serial Port COM1 & COM2 Port Connectors

This motherboard provides two COM ports, you can connect an external modem, mouse or other devices that support this communication protocol to these connectors.

You can decide which external devices you want to connect to COM1 and COM2. Each COM port can only have one device connected at a time.



External FAX/Modem



Digital Tablet



Digital Camera

Parallel Port Connector

This parallel port is also called an “LPT” port, because it usually connects to the printer. You can connect other devices that support this communication protocol, like an EPP/ECP scanner, etc.

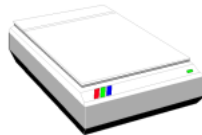
**Laser Printer****Inkjet Printer****EPP/ECP Scanner****Note**

This chapter contains many color drawing diagram and photos, we strongly recommend you to read this chapter use the PDF file we gave you that store in the CD-Title. It will provide you the better look and clearly color identify.

Chapter 3. Introducing the BIOS

The BIOS is a program located on a Flash Memory chip on the motherboard. This program will not be lost when you turn the computer off. This program is also referred to as the boot program. It is the only channel the hardware circuit has to communicate with the operating system. Its main function is to manage the setup of the motherboard and interface card parameters, including simple parameters such as time, date, hard disk drive, as well as more complex parameters such as hardware synchronization, device operating mode, **SOFT MENU™ III** features and setup of CPU speed. The computer will operate normally, or will operate at its best, only if all of these parameters are correctly configured through the BIOS.



Don't change the parameters inside the BIOS unless you fully understand the meanings and consequences

The parameters inside the BIOS are used to setup the hardware synchronization or the device-operating mode. If the parameters are not correct, they will produce errors, the computer will crash, and sometimes you will even not be able to boot the computer after it has crashed. We recommend that you do not change the parameters inside the BIOS unless you are very familiar with them. If you are not able to boot your computer anymore, please refer to the section “Erase CMOS data” in Chapter 2.

When you start the computer, the BIOS program controls it. The BIOS first operates an auto-diagnostic test called POST (Power On Self Test) for all of the necessary hardware. It then configures the parameters of the hardware synchronization, and detects all of the hardware. Only when these tasks are completed does it give up control of the computer to the program to the next level, which is the operating system (OS). Since the BIOS is the only channel for hardware and software to communicate, it is the key factor for system stability, and in insuring that your system performs at its best. After the BIOS has achieved the auto-diagnostic and auto-detection operations, it will display the following message:

PRESS DEL TO ENTER SETUP

The message will be displayed for three to five seconds, if you press the **Del** key, you will access the BIOS Setup menu. At that moment, the BIOS will display the following message:

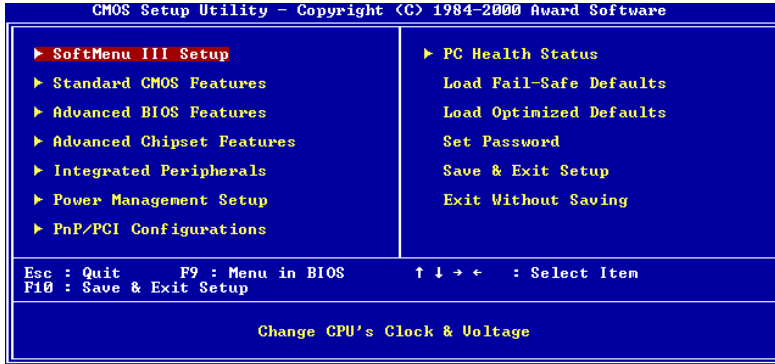

Figure 3-1. CMOS Setup Utility

In the BIOS Setup main menu of Figure 3-1, you can see several options. We will explain these options step by step in the following pages of this chapter, but let us first see a short description of the function keys you may use here:

- Press **Esc** to quit the BIOS Setup.
- Press **↑ ↓ ← →** (up, down, left, right) to choose, in the main menu, the option you want to confirm or to modify.
- Press **F10** when you have completed the setup of BIOS parameters to save these parameters and to exit the BIOS Setup menu.
- Press Page Up/Page Down or +/- keys when you want to modify the BIOS parameters for the active option.

Computer Knowledge: CMOS Data

Maybe you have heard somebody saying that his or her CMOS DATA was lost. What is the CMOS? Is it important? The CMOS is the memory used to store the BIOS parameters that you have configured. This memory is passive. You can read its data, and you can also store data in it. But this memory has to be powered by a battery, in order to avoid any loss of its data when the computer is turned off. Since you may have to change the CMOS battery when it is out of power and if doing so, you will lose all CMOS data, therefore, we recommend that you write down all the parameters of your hardware, or to put a label with these parameters on your hard disk.

3-1. CPU Setup [SOFT MENU™ III]

The CPU can be setup through a programmable switch (**CPU SOFT MENU™ III**), that replaces the traditional manual hardware configuration. This feature allows the user to more easily complete the installation procedures. You can install the CPU without configuring any jumpers or switches. The CPU must be setup according its specifications.

In the first option, you can press <F1> at any time to display all the items that can be chosen for that option.

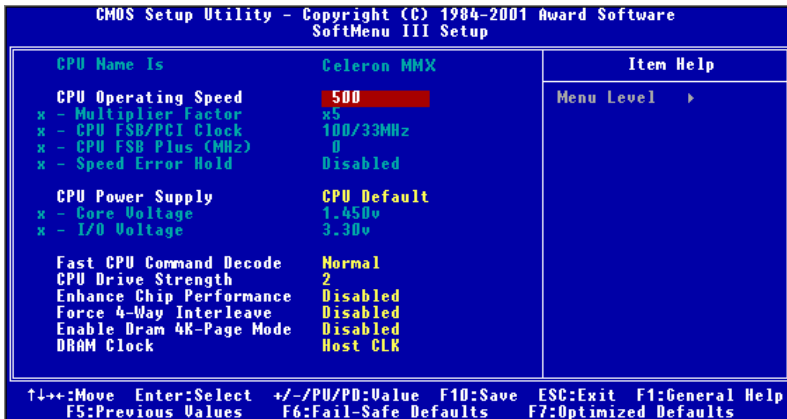

Figure 3-2. CPU SOFT MENU™ III

CPU Name Is:

- AMD Athlon
- AMD Duron

CPU Operating Speed:

This option sets the CPU speed. In this field, the CPU speed is indicated like this: CPU speed = External clock * Multiplier factor, select the CPU speed according to the type and the speed of your CPU. For AMD Duron™ processors, you can choose the following settings:

- 500 ➤550 ➤600 ➤650 ➤700 ➤750 ➤800
- 850 ➤900 ➤950 ➤1000 ➤1050 ➤1100 ➤1150
- 1200 ➤1250 ➤User Define

User defined external clock and multiplier factor:

➤ User Defined



Warning



The wrong settings of the multiplier and external clock in certain circumstances may cause CPU damage

The wrong settings of the multiplier and external clock in certain circumstances may cause CPU damage. Setting the working frequency higher than the specifications of PCI or of processor may cause abnormal memory module functioning, system hangs, hard disk drive data loss, abnormal functioning of the VGA card, or abnormal functioning with other add-on cards. Using non-specification settings for your CPU is not the intention of this explanation, for which should be used for engineering testing only, not for normal applications.

If you use non-specification settings for normal operation, your system may not be stable, and may effect system reliability. Also, we do not guarantee the stability and compatibility for settings that are not within specification, and any damage of any elements on the motherboard or peripherals, is not our responsibility.

— Multiplier Factor:

There are several settings, shown as below:

- x5 ➤x5.5 ➤x6 ➤x6.5 ➤x7 ➤x7.5 ➤x8 ➤x8.5 ➤x9
- x9.5 ➤x10 ➤x10.5 ➤x11 ➤x11.5 ➤x12 ➤x12.5

— CPU FSB/PCI Clock:

There are several settings, the relationship between two numbers, left side is processor front side bus speed, right side is PCI bus speed.

- 100/33MHz ➤101/33MHz ➤103/34MHz ➤105/35MHz ➤107/35MHz
- 110/36MHz ➤112/37MHz ➤115/38MHz ➤117/39MHz ➤120/40MHz
- 122/40MHz ➤124/41MHz ➤127/42MHz ➤133/44MHz ➤136/34MHz
- 140/35MHz ➤145/34MHz ➤150/37MHz ➤155/38MHz

— CPU FSB Plus (MHz):

You can increase CPU FSB speed here. This means that you can increase the setting of the “CPU FSB/PCI Clock” item, and also independently increase the CPU FSB speed. Twenty-nine options are available: 0~28, with the default setting at 0. You can change this setting to increase CPU FSB speed. CPU FSB speed above the standard bus speed is supported, but not guaranteed due to the CPU specs.

— Speed Error Hold:

The default setting is “Disabled”. If you change the setting to “Enabled” when the CPU speed setting is wrong, the system will hold.

Normally, we do not recommend that you use the “User Define” option to setup CPU speed and PCI clock. This option is for setup of future CPUs whose specifications are still unknown. The specifications of all present CPUs are included in the default settings. Unless you are very familiar with all CPU parameters, it is very easy to make mistakes when you define the external clock and the multiplier factor by yourself.

Solution in case of booting problem due to invalid clock setup:

Normally, if the CPU clock setup is wrong, you will not be able to boot. In this case, turn the system off then on again. The CPU will automatically use its standard parameters to boot. You can then enter the BIOS Setup again and set up the CPU clock. If you can't enter the BIOS setup, you must try turning the system on a few times (3~4 times) or press “INSERT” key when turning on and the system will automatically use its standard parameters to boot. You can then enter BIOS SETUP again and set up the new parameters.

When you change your CPU:

This motherboard has been designed in such a way that you can turn the system on after having inserted a CPU in the socket without having to configure any jumpers or DIP switches. But if you change your CPU, normally you just have to turn off the power supply, change the CPU and then, set up the CPU parameters through **SOFT MENU™ III**. However, if the new CPU is slower than the old one (and is same brand and type), we offer you two methods to successfully complete the CPU change operation.

Method 1: Setup up the CPU for the lowest speed for its brand. Turn the power supply off and change the CPU. Then turn the system on again, and set up the CPU parameters through **SOFT MENU™ III**.

Method 2: Since you have to open the computer case when you change the CPU, it could be a good idea to use the CCMOS jumper to erase the parameters of the original CPU and to enter BIOS Setup to set up CPU parameters again.

Attention

After setting up the parameters and leaving the BIOS SETUP, and having verified that the system can be booted, do not press the Reset button or turn off the power supply. Otherwise the BIOS will not read correctly, the parameters will fail and you must enter **SOFT MENU™ III** again to set up the parameters all over again.

CPU Power Supply:

This option allows you to switch between CPU default and user-defined voltages.

- ▶ **CPU Default:** The system will detect the CPU type and select the proper voltage automatically. When it is enabled, the option “**Core Voltage**” will show the current voltage setting that is defined by the CPU and this will not be changeable. We recommend using this CPU default setting and not changing it unless the current CPU type and voltage setting can not be detected or is not correct.
- ▶ **User Define:** This option lets the user select the voltage manually. You can change values of the “**Core Voltage**” and “**I/O Voltage**” option lists by using the arrow up and arrow down keys.

Fast CPU Command Decode:

Two options are available: Normal → Fast. The default setting is *Normal*. With this setting, you may select ‘fast’ if you want CPU decode address out 1T early. We suggest you choose “Normal” for greatest stability. Should you want increased performance, then you can select “Fast”.

CPU Drive Strength:

Four options are available: 0 → 1 → 2 → 3. The default setting is 2. This option will effect the signal strength with data transfer from the north bridge chipset to the CPU. If you want the greatest stability, we suggest you choose “2”.

Enhance Chip Performance:

Two options are available: Disabled → Enabled. The default setting is *Disabled*. If you choose “Enabled,” it will set the north bridge chipset timing parameters more aggressively, providing higher system performance.

Force 4-Way Interleave:

Two options are available: Disabled → Enabled. The default setting is *Disabled*. If you choose “Enabled,” it will force DRAM to run in 4-Way interleave mode.

Enable Dram 4K-Page Mode:

Two options are available: Disabled → Enabled. The default setting is *Disabled*. If you choose “Enabled,” and the DRAM uses 64Mbit technology, the 4K-Page mode will increase your DRAM’s speed.

DRAM Clock:

Two options are available: Host CLK → HCLK+PCICLK. The default setting is Host CLK. This option is used to set the working speed of SDRAM. It is the same as CPU working frequency or plus PCI clock.

3-2. Standard CMOS Features Setup Menu

This contains the basic configuration parameters of the BIOS. These parameters include date, hour, VGA card, Floppy Disk and HDD settings.

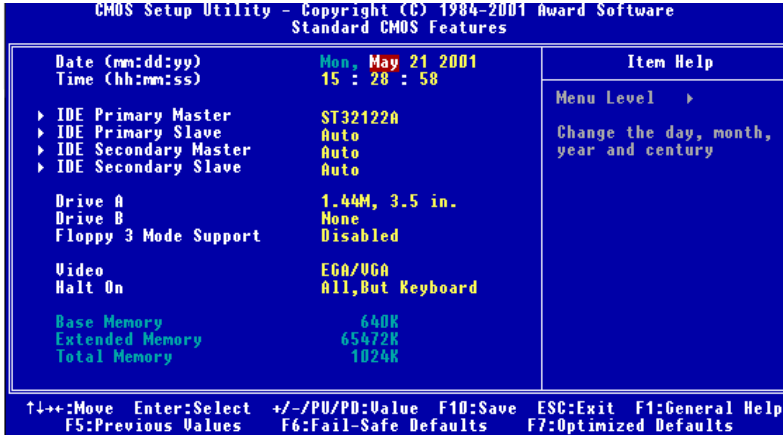

Figure 3-3A. Standard CMOS Setup Screen Shot

Date (mm:dd:yy):

You can set the date in this item: month (mm), date (dd) and year (yy).

Time (hh:mm:ss):

You can set the time in this item: hour (hh), minute (mm) and second (ss).

IDE Primary Master / Slave and IDE Secondary Master / Slave:

These items have a sub-menu to let you choose further options. You can refer to figure 3-3B to check what options are available.

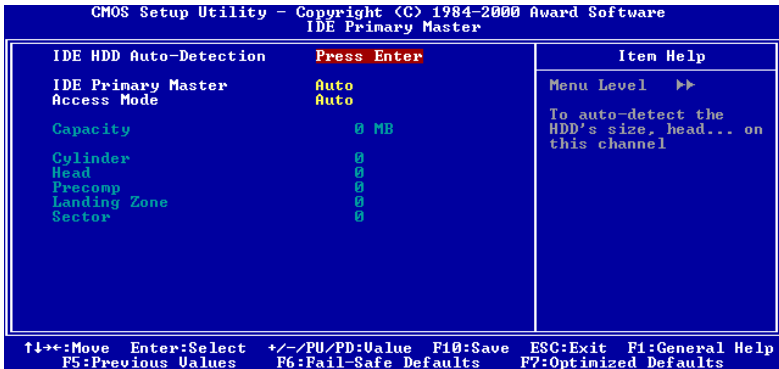

Figure 3-3B. IDE Primary Master Setup Screen Shot

IDE HDD Auto-Detection:

Press the *Enter* key for the BIOS to auto detect all detailed parameters of the hard disk drivers (HDD). If auto detection is successful, the correct values will be shown in the remaining items of this menu.

Note

- ❶ A new IDE HDD must be first formatted, otherwise it can not read/write. The basic step in using a HDD is to run FDISK, and then FORMAT the drive. Most current HDDs have already been subjected to low-level format at the factory, so you can probably skip this operation. Remember though, the primary IDE HDD must have its partition set to active within the FDISK procedure.
- ❷ If you are using an old HDD that is already formatted, auto detection can not detect the correct parameters. You may need to do a low-level format or set the parameters manually, and then check if the HDD is working.

IDE Primary Master:

Three settings are available: *Auto*, *Manual* and *None*. If you choose *Auto*, the BIOS will automatically check what kind hard disk you are using. If you want to set the HDD parameters yourself, make sure you fully understand the meaning of the parameters, and be sure to refer to the manual provided by the HDD manufacture to get the settings right.

Access Mode:

Since old operating systems were only able to support HDDs with capacities no bigger than 528MB, any hard disk with more than 528MB was unusable. AWARD BIOS features a solution to this problem: you can, according to your operating system, choose four operating modes: NORMAL → LBA → LARGE → Auto.

The HDD auto detection option in the sub-menu will automatically detect the parameters of your hard disk and the mode supported.

► Auto:

Just let the BIOS detect your HDD access mode and make the decisions.

► Normal mode:

Standard normal mode supports hard disks of up to 528MB or less. This mode directly uses positions indicated by Cylinders (CYLS), Heads, and Sectors to access data.

► LBA (Logical Block Addressing) mode:

The earlier LBA mode can support HDD capacities of up to 8.4GB, and this mode uses a different method to calculate the position of disk data to be accessed. It translates Cylinders (CYLS), Heads and Sectors into a logical address where data is located. The Cylinders, Heads, and Sectors displayed in this menu do not reflect the actual structure of the hard disk, they are just reference values used to calculate actual positions. Currently, all high capacity hard disks support this mode, that's why we recommend you use this mode. Currently, the BIOS can support the INT 13h extension function, enabling the LBA mode to support hard disk drive capacities exceeding 8.4GB.

► Large Mode:

When the number of cylinders (CYLS) of the hard disk exceeds 1024 and DOS is not able to support it, or if your operating system does not support LBA mode, you should select this mode.

Capacity:

This item auto displays your HDD size. Note that this size is usually slightly greater than the size given by a disk checking program of a formatted disk.

Note

All the items below are available when you set the item *Primary IDE Master* to *Manual*.

Cylinder:

When disks are placed directly above one another along the shaft, the circular vertical "slice" consisting of all the tracks located in a particular position is called a cylinder. You can set the number of cylinders for a HDD. The minimum number you can enter is 0, the maximum number you can enter is 65536.

Head:

This is the tiny electromagnetic coil and metal pole used to create and read back the magnetic patterns on the disk (also called the read/write head). You can configure the number of read/write heads. The minimum number you can enter is 0, the maximum number you can enter is 255.

Precomp:

The minimum number you can enter is 0, the maximum number you can enter is 65536.

Warning

Setting a value of 65536 means no hard disk exists.

Landing Zone:

This is a non-data area on the disk's inner cylinder where the heads can rest when the power is turned off. The minimum number you can enter is 0, the maximum number you can enter is 65536.

Sector:

The minimum segment of track length that can be assigned to stored data. Sectors usually are grouped into blocks or logical blocks that function as the smallest units of data permit. You can configure this item to sectors per track. The minimum number you can enter is 0, the maximum number you can enter is 255.

Driver A & Driver B:

If you have installed the floppy disk drive here, then you can select the type of floppy drive it can support. Six options are available: None → 360K, 5.25 in. → 1.2M, 5.25 in. → 720K, 3.5 in. → 1.44M, 3.5 in. → 2.88M, 3.5 in.

Floppy 3 Mode Support:

Four options are available: Disabled → Driver A → Driver B → Both. The default setting is *Disabled*. 3 Mode floppy disk drives (FDD) are 3 1/2" drives used in Japanese computer systems. If you need to access data stored in this kind of floppy, you must select this mode, and of course you must have a 3 Mode floppy drive.

Video:

You can select the VGA modes for your video adapter, four options are available: EGA/VGA → CGA 40 → CGA 80 → MONO. The default setting is EGA/VGA.

Halt On:

You can select which type of error will cause the system to halt. Five options are available: All Errors → No Errors → All, But Keyboard → All, But Diskette → All, But Disk/Key.

You can see your system memory list in the lower right box, it shows the *Base Memory*, *Extended Memory* and *total Memory size* configurations in your system. It is detected by the system during boot-up procedure.

3-3. Advanced BIOS Features Setup Menu

In each item, you can press <Enter> at any time to display all the options for this item.

Attention

Advanced BIOS Features Setup Menu has already been set for maximum operation. If you do not really understand each of the options in this menu, we recommend you use the default values.



Figure 3-4A. Advanced BIOS Features Setup Upper Screen



Figure 3-4B. Advanced BIOS Features Setup Lower Screen

Virus Warning:

This item can be set to Enabled or Disabled, the default setting being *Disabled*.

When this feature is enabled, if there is any attempt from a software or an application to access the boot sector or the partition table, the BIOS will warn you that a boot virus is attempting to access the hard disk.

Quick Power On Self Test:

After the computer has been powered on, the BIOS of the motherboard will run a series of tests in order to check the system and its peripherals. If the Quick Power on Self-Test feature is enable, the BIOS will simplify the test procedures in order to speed up the boot process. The default setting is *Enabled*.

First Boot Device:

When the computer boots up, the BIOS attempts to load the operating system from the devices in the sequence selected in these items: floppy disk drive A, LS120, ZIP100 devices, hard drive C, SCSI hard disk drive or CD-ROM. There are ten options for the boot sequence that you can choose (The default setting is *Floppy*):

Floppy → LS120 → HDD-0 → SCSI → CDROM → HDD-1 → HDD-2 → HDD-3 → ZIP100 → LAN → Back to Floppy.

Floppy → LS120 → HDD-0 → SCSI → CDROM → HDD-1 → HDD-2 → HDD-3 → ZIP100 → LAN → ATA100RAID → Back to Floppy. (**KT7-RAID/KT7A-RAID Only**)

Second Boot Device:

Description is the same as the *First Boot Device*, the default setting is *HDD-0*.

Third Boot Device:

Description is same as the *First Boot Device*, the default setting is *LS120*.

Boot Other Device:

Two options are available: Enabled or Disabled. The default setting is *Enabled*. This setting allows the BIOS to try to boot devices other than the three which are listed in the above First, Second and Third Boot Devices. If you set to Disabled, the BIOS will boot from only the three kinds of boot devices that are set above.

Swap Floppy Drive:

This item can be set as Enabled or Disabled. The default setting is *Disabled*. When this feature is enabled, you don't need to open the computer case to swap the position of floppy disk drive connectors. Drive A can be set as drive B and drive B can be set as drive A.

Boot Up Floppy Seek:

When the computer boots up, the BIOS detects if the system has a FDD or not. When this item is enable, if the BIOS detects no floppy drive, it will display a floppy disk drive error message. If this item is disabled, the BIOS will skip this test. The default setting is *Disabled*.

Boot Up NumLock Status:

- On: At boot up, the Numeric Keypad is in numeric mode. (Default Settings)
 - Off: At boot up, the Numeric Keypad is in cursor control mode.
-

Type matic Rate Setting:

This item allows you to adjust the keystroke repeat rate. When set to *Enabled*, you can set the two keyboard typematic controls that follow (*Typematic Rate* and *Typematic Rate Delay*). If this item is set to *Disabled*, the BIOS will use the default setting. The default setting is *Enabled*.

Type matic Rate (Chars/Sec):

When you press a key continuously, the keyboard will repeat the keystroke according to the rate you have set (Unit: characters/second) . Eight options are available: 6 → 8 → 10 → 12 → 15 → 20 → 24 → 30 → Back to 6. The default setting is 30.

Type matic Delay (Msec):

When you press a key continuously, if you exceed the delay you have set here, the keyboard will automatically repeat the keystroke according to a certain rate (Unit: milliseconds). Four options are available: 250 → 500 → 750 → 1000 → Back to 250. The default setting is 250.

Security Option:

This option can be set to System or Setup. The default setting is *Setup*. After you have created a password through PASSWORD SETTING, this option will deny access to your system (System) or modification of computer setup (BIOS Setup) by unauthorized users.

- **SYSTEM:** When you choose System, a password is required each time the computer boots up. If the correct password is not given, the system will not start.
 - **SETUP:** When you choose Setup, a password is required only when accessing the BIOS Setup. If you have not set a password in the PASSWORD SETTING option, this option is not available.
-

To disable security, select *Set Supervisor Password* at main menu and then you will be asked to enter password. Do not type anything and just press the *Enter* key and it will disable security. Once security is disabled, the system will boot and you can enter the *BIOS setup menu* freely.

Notice

Don't forget your password. If you forget the password, you will have to open the computer case and clear all information in the CMOS before you can start up the system. But by doing this, you will have to reset all previously set options.

OS Select For DRAM > 64MB:

When the system memory is bigger than 64MB, the communication method between the BIOS and the operating system will differ from one operating system to another. If you use OS/2, select *OS2*; if you are using another operating system, select *Non-OS2*. The default setting is *Non-OS2*.

Video BIOS Shadow:

This option is used to define whether the BIOS on the video card uses the shadow feature or not. You should set this option to Enabled, otherwise the display performance of the system will greatly decrease.

Shadowing address ranges:

This option allows you to decide if the ROM BIOS area of an interface card at a specific address uses the shadow feature or not. If you have no interface card using this memory block, don't enable this option. You have six address ranges you can select:

C8000-CBFFF Shadow, CC000-CFFFF Shadow, D0000-D3FFF Shadow, D4000-D7FFF Shadow, D8000-DBFFF Shadow, DC000-DFFFF Shadow.

Computer Knowledge: SHADOW

What is the SHADOW? The BIOS of standard video or interface cards is stored in ROM, and it is often very slow. With the Shadow feature, the CPU reads the BIOS on the VGA card and copies it into RAM. When the CPU runs this BIOS, the operation is speeded up.

Delay For IDE Initial (Secs):

This item is used to support some old models or special types of hard disks or CD-ROMs. They may need a longer amount of time to initialize and prepare for activation. Since the BIOS may not detect those kinds of devices during system booting. You can adjust the value to fit such devices. Larger values will give more delay time to the device. The minimum number you can enter is 0, the maximum number you can enter is 15. The default setting is 0.

3-4. Advanced Chipset Features Setup Menu

The Chipset Features Setup Menu is used to modify the contents of the buffers in the chipset on the motherboard. Since the parameters of the buffers are closely related to hardware, if the setup is not correct or is false, the motherboard will become unstable or you will not be able to boot up. If you don't know the hardware very well, use default values (i.e. use the LOAD SETUP DEFAULTS option).

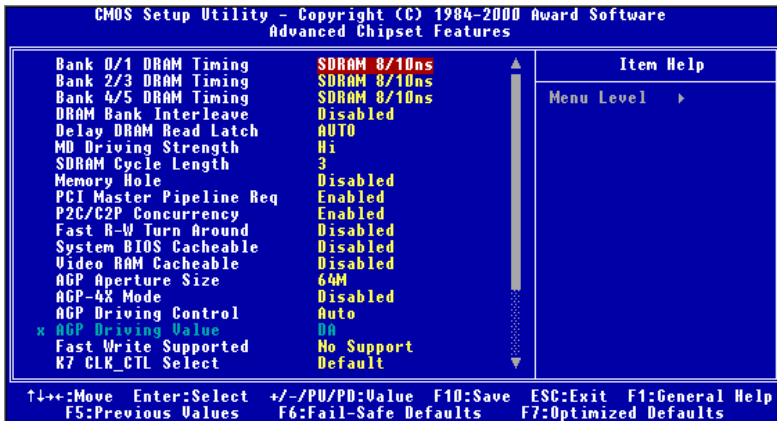

Figure 3-5A. Advanced Chipset Features Setup Upper Screen

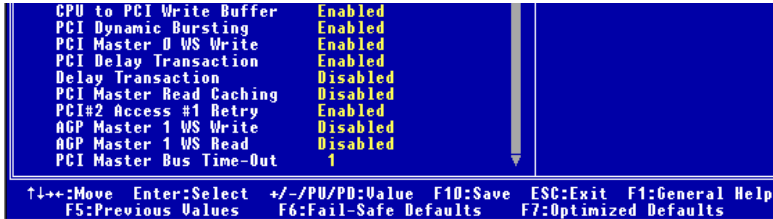

Figure 3-5B. Advanced Chipset Features Setup Lower Screen

You can use the arrow keys to move between the items. Use **PgUP**, **PgDn**, **+** or **-** key to change the values. When you have finished setting up the chipset, press **ESC** to go back to the main menu.

Note

The parameters in this screen are for system designers, service personnel, and technically competent users only. Do not reset these values unless you understand the consequences of your changes.

Bank 0/1, 2/3, 4/5 DRAM Timing:

The DRAM timing of Bank 0/1, 2/3, 4/5 in this field is set by the motherboard manufacturer, depending on whether memory module preset. For end users, we do not suggest that you to change the setting. Except when you actually know what kind memory module you use.

The Choice: SDRAM 8/10ns → Normal → Medium → Fast → Turbo → Back to SDRAM 10ns. The default setting is *SDRAM 8/10ns*.

DRAM Bank Interleave:

Three options are available: Disabled → 2-Way → 4-Way. The default setting is *Disabled*. This option can active the DRAM bank interleave, 4-Way is the fastest choose.

Delay DRAM Read Latch:

Five options are available: Auto → No Delay → 0.5ns → 1.0ns → 1.5ns. The default setting is *Auto*. This option sets the time required to catch DRAM data. If the DRAM load is heavy for example, such as would be the case if you were to install three double side DRAM modules in the DIMM slots, you may need to choose a longer delay time for data reading.

MD Driving Strength:

Two options are available: Hi → Lo. The default setting is *Hi*. This setting lets you adjust the driving strength from the north bridge to the memory data line. If your memory loading is heavy, we suggest you choose Hi for better driving capability.

SDRAM Cycle Length:

Two options are available: 2 or 3. This option sets the CAS latency timing of the DRAM system memory access cycle when the SDRAM system memory is installed on the motherboard. The default setting is 3.

Memory Hole:

Two options are available: Disabled or 15M - 16M. The default setting is *Disabled*. This option is used to free up the memory block 15M-16M. Some special peripherals need to use a memory block located between 15M and 16M, and this memory block has a size of 1M. We recommend that you disable this option.

PCI Master Pipeline Req:

Two options are available: Disabled or Enabled. The default setting is *Enabled*.

P2C/C2P Concurrency:

Two options are available: Disabled or Enabled. The default setting is *Enabled*. This item allows you to enable/disable the PCI to CPU, CPU to PCI concurrency.

Fast R-W Turn Around:

Two options are available: Disabled or Enabled. The default setting is *Disabled*. This item controls the DRAM timing. It allows you to enable/disable the fast read/write turn around.

System BIOS Cacheable:

Two options are available: Disabled or Enabled. The default setting is *Disabled*. When you select Enabled, you get faster system BIOS executing speed via the L2 cache.

Video RAM Cacheable:

Two options are available: Disabled or Enabled. The default setting is *Disabled*. When you select Enabled, you get faster video RAM executing speed via the L2 cache. You must check your VGA adapter manual to find out if any compatibility problems will occur.

AGP Aperture Size:

Six options are available: 4M → 8M → 16M → 32M → 64M → 128M → Back to 4M. The default setting is *64M*. This option specifies the amount of system memory that can be used by the AGP device. The aperture is a portion of the PCI memory address range dedicated for graphics memory address space. Host cycles that hit the aperture range are forwarded to the AGP without any translation. See www.agpforum.org for AGP information.

AGP-4X Mode:

Two options are available: Disabled or Enabled. The default setting is *Disabled*. If you use the older AGP adapter that does not support AGP 4X mode, you need to set this item to Disabled.

AGP Driving Control:

Two options are available: Auto or Manual. The default setting is *Auto* allows you to adjust the AGP driving force. Choosing *Manual* to key in an AGP Driving Value is described within the next section. It is recommended this field be set at Auto in order to avoid any errors in your system.

— *AGP Driving Value:*

This item allows you to adjust the AGP driving force. You can key in the HEX number into this section. The minimum number is 00, and maximum number is FF. The default setting is *DA*.

Fast Write Supported:

Two options are available: No Support or Supported. The default setting is *No Support*. If your AGP adapter can support this function, then you can choose Supported. Otherwise, choose No Support.

K7 CLK_CTL Select:

Two options are available: Default or Optimal. The default setting is *Default*. This item can decide some of the internal parameters which can optimize the CPU. If you choose Optimal, AMD's suggested optimal values will be used. Or you can use the default settings by choosing Default.

CPU to PCI Write Buffer:

Two options are available: Disabled or Enabled. The default setting is *Enabled*. When enabled, up to four words of data can be written to the PCI bus without interrupting the CPU. When disabled, a write buffer is not used and the CPU read cycle will not be completed until the PCI bus signals that it is ready to receive the data. Because the CPU speed running faster than PCI bus, the CPU must wait as the PCI bus receives data before starting each write cycle.

PCI Dynamic Bursting:

Two options are available: Disabled or Enabled. The default setting is *Enabled*. When Enabled, every write transaction goes to the write buffer. Burstable transactions then burst on the PCI bus and nonburstable transactions don't. Which means, when you set to disabled, if the write transaction is a burst transaction, the information go to the write buffer and burst transfers are perform on the PCI bus later. If the transaction is not a burst transaction, PCI write will occur immediately. (it will active after a write buffer flush)

PCI Master 0 WS Write:

Two options are available: Disabled or Enabled. The default setting is *Enabled*. When *Enabled*, writes to the PCI bus are executed with zero wait states (immediately), when PCI bus is ready to receive data. If disabled, the system will wait one state before data is written to the PCI bus.

PCI Delay Transaction (PCI Master To ISA Delay Transaction):

Two options are available: Enabled and Disabled. The default setting is *Enabled*. Setting the option to enabled or disabled allows for the PCI 2.1 features, including passive release and delayed transaction for the chipset. This function is used to meet the latency of PCI cycles to or from the ISA bus. This option must be enabled to provide PCI 2.1 compliance. If you have an ISA card compatibility problem, you can try to enable or disable this option for optimal results. This delay transaction mechanism is also implemented for further

improvement of overall system performance.

Delay Transaction (PCI Master To DRAM Delay Transaction):

Two options are available: Disabled or Enabled. The default setting is *Disabled*. The chipset has an embedded 32-bit posted write buffer to support delay transactions cycles. Select Enabled to support compliance with PCI specification version 2.1. This delay transaction mechanism is also implemented for further improvement of overall system performance.

PCI Master Read Caching :

Two options are available: Disabled or Enabled. The default setting is *Disabled*. This PCI Master read caching mechanism can improve the PCI Master reading speed, if the data already read and it still stored in cache mechanism.

PCI#2 Access #1 Retry:

Two options are available: Disabled or Enabled. The default setting is *Enabled*. This item allows you enable/disable the PCI #2 Access #1 Retry. When you set the PCI#2 Access#1 to Enabled, the AGP bus will attempt to access the PCI bus at a limited time period before being disconnected. When you set it to Disabled, the AGP bus will try to access the PCI bus until it successfully accesses the PCI bus.

AGP Master 1 WS Write:

Two options are available: Disabled or Enabled. The default setting is *Disabled*. This implements a single delay when writing to the AGP Bus. When you set it to Disabled, two-wait states are used by the system, allowing for greater stability.

AGP Master 1 WS Read:

Two options are available: Disabled or Enabled. The default setting is *Disabled*. This implements a single delay when reading to the AGP Bus. By default, two-wait states are used by the system, allowing for greater stability.

PCI Master Bus Time-Out:

Sixteen options are available. You can enter the DEC number from 0 to 15. The default setting is 1. This item can force the PCI master bus into arbitration after a period of time. The larger numbers can hold for a longer period of time.

3-5. Integrated Peripherals

In this menu, you can change the onboard I/O device, I/O port address and other hardware settings.

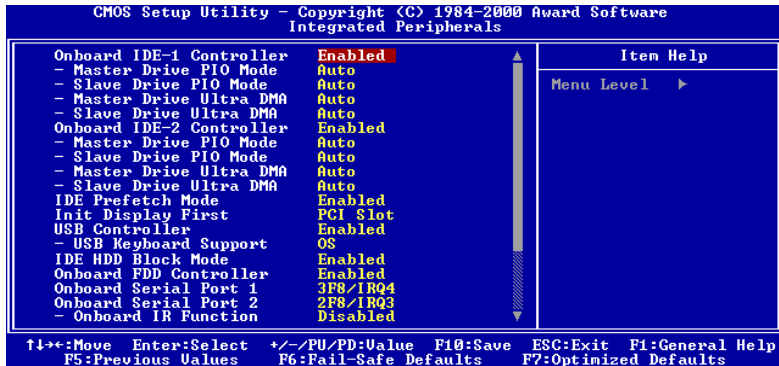

Figure 3-6A. Integrated Peripherals Menu Default Screen (KT7/KT7A)

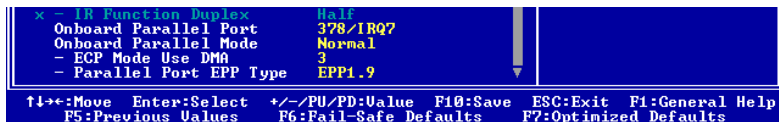

Figure 3-6B. Integrated Peripherals Menu Full Items Screen (KT7/KT7A)

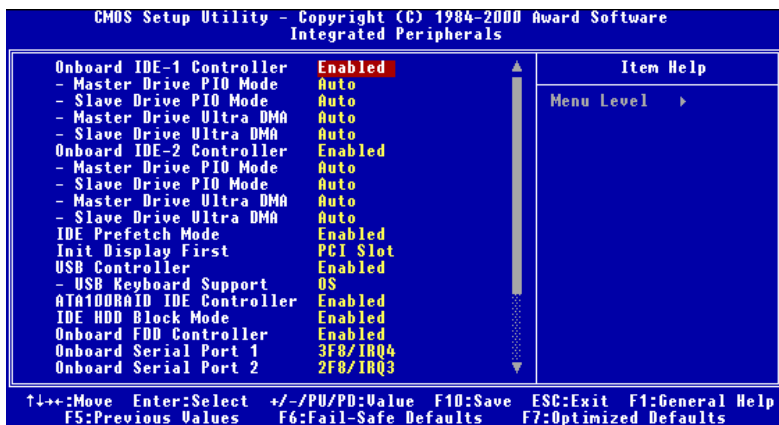

Figure 3-6C. Integrated Peripherals Menu Default Screen (KT7(A)-RAID)

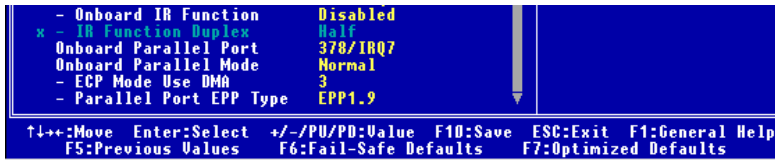

Figure 3-6D. Integrated Peripherals Menu Full Items Screen (KT7(A)-RAID)

Onboard IDE-1 Controller:

The onboard IDE 1 controller can be set as Enabled or Disabled.

— Master Drive PIO Mode:

- Auto: The BIOS can auto-detect the transfer mode of the IDE devices in order to set its data transfer rate. (Default)

You can select the PIO mode from 0 to 4 of the IDE devices in order to set its data transfer rate.

— Slave Drive PIO Mode:

- Auto: The BIOS can auto-detect the transfer mode of the IDE devices in order to set its data transfer rate. (Default)

You can select the PIO mode from 0 to 4 of the IDE devices in order to set its data transfer rate.

— Master Drive Ultra DMA:

Ultra DMA is a DMA data transfer protocol that utilizes ATA commands and the ATA bus to allow DMA commands to transfer data at a maximum burst rate of 66 MB/sec.

- Auto: When you select *Auto*, the system automatically determines the optimal data transfer rate for each IDE device. (Default)
- Disabled: If you encounter the problem of using Ultra DMA devices, you can try to *Disable* this item.

— Slave Drive Ultra DMA:

- Auto: When you select *Auto*, the system automatically determines the optimal data transfer rate for each IDE device. (Default)
 - Disabled: If you encounter the problem of using Ultra DMA devices, you can try to *Disable* this item.
-

Onboard IDE-2 Controller:

The onboard IDE 2 controller can be set as Enabled or Disabled. Description is the same as the item “Onboard IDE-1 Controller”, you can refer the above description.

PIO MODE 0~4 reflects the IDE device data transfer rate. The higher the MODE value is, the better is the IDE device data transfer rate. But it does not mean that you can select the highest MODE value just as you like, you first have to be sure that your IDE device supports this MODE, otherwise the hard disk will not be able to operate normally.

IDE Prefetch Mode:

Two options are available: Disabled or Enabled. The default setting is *Enabled*. The onboard IDE drive interfaces supports IDE prefetching, for faster drive accesses. If you install a primary and/or secondary add-in IDE interface, set this field to *Disabled* if the interface does not support prefetching.

Init Display First:

Two options are available: PCI Slot or AGP. The default setting is *PCI Slot*. When you install more than one display cards, you can choose either a PCI display card (PCI Slot) or an AGP display card (AGP) to activate the display boot-up screen. If you only installed one display card, the BIOS will detect which slot (AGP or PCI) you installed it, in then everything will be take care of by the BIOS.

USB Controller:

Two options are available: Disabled or Enabled. The default setting is *Enabled*. This should be enabled if your system has a USB installed on the system board and you wish to use it. Even when so equipped, if you add a higher performance controller, you will need to disable this feature. If you choose disable this item, the “USB Keyboard Support” item will disappear in *Chipset Features Setup* menu.

— *USB Keyboard Support:*

Two options are available: BIOS and OS. The default setting is *OS*. If your operating system supports a USB keyboard, please set it to *OS*. Only in some situations, such as in a pure DOS environment that does not support a USB keyboard, should you set it to BIOS.

ATA100RAID IDE Controller (KT7-RAID/KT7A-RAID Only):

Two options are available: Disabled or Enabled. The default setting is *Enabled*. If your motherboard is the KT7-RAID or KT7A-RAID, it has the built-in HighPoint 370 chipset which can support Ultra ATA/100 specifications.

IDE HDD Block Mode:

This item can be set as Enabled or Disabled.

Most of new hard disk drives (IDE drives) support multi-sector transfers. This feature speeds up hard disk drive access performance and reduces the time necessary to access data. When this item is enabled, the BIOS will automatically detect if your hard disk drive supports this feature or not, and will choose the right settings for you. (*The default is Enabled*)

Onboard FDD Controller:

Two options are available: Disabled or Enabled. The default setting is *Enabled*. This is set to Enabled or Disabled the Onboard FDD Controller. If you add a higher performance controller, you will need to disable this feature.

Onboard Serial Port 1:

This item allows you to determine access onboard serial port 1 controller with which I/O address. Six options are available: Auto → Disabled → 3F8/IRQ4 → 2F8/IRQ3 → 3E8/IRQ4 → 2E8/IRQ3 → Back to Auto. The default setting is *3F8/IRQ4*.

Onboard Serial Port 2:

This item allows you to determine access onboard serial port 2 controller with which I/O address. Six options are available: Auto → Disabled → 3F8/IRQ4 → 2F8/IRQ3 → 3E8/IRQ4 → 2E8/IRQ3 → Back to Auto. The default setting is *2F8/IRQ3*.

If you choose “Disabled”, then item “Onboard IR Function” will disappear.

Onboard IR Function:

Three options are available: Disabled → HPSIR → ASKIR (Amplitude Shift Keyed IR). The default setting is *Disabled*.

When you select the item HPSIR or ASKIR, then the following two items will appear.

— **IR Function Duplex:**

Two options are available: Half or Full. The default setting is *Half*.

Select the value required by the IR device connected to the IR port. Full-duplex mode permits simultaneous two-direction transmission. Half-duplex mode permits transmission in one direction only at a time.

Onboard Parallel Port:

Four options are available: 378/IRQ7 → 278/IRQ5 → Disabled → 3BC/IRQ7. The default setting is 378/IRQ7. Select a logical LPT port name and matching address for the physical parallel (printer) port.

Onboard Parallel Mode:

Four options are available: Normal → EPP → ECP → ECP+EPP. Default is *Normal* mode. Select an operating mode for the onboard parallel (printer) port. Normal (SPP, Standard Parallel Port), EPP (Extended Parallel Port), ECP (Extended Capabilities Port) or ECP plus EPP.

Select Normal unless you are certain your hardware and software both support EPP or ECP mode. According your select the following items will separate show up.

— **ECP Mode Use DMA:**

When the mode selected for the onboard parallel port is ECP or ECP+EPP, the DMA channel selected can be 1 (Channel 1) or 3 (Channel 3).

— **Parallel Port EPP Type:**

Two options are available: EPP1.7 → EPP1.9. The default setting is EPP 1.9. When the mode selected for the parallel port mode is EPP, the two EPP version options are available.

3-6. Power Management Setup Menu

The difference between Green PCs and traditional computers is that Green PCs have a power management feature. With this feature, when the computer is powered on but inactive, the power consumption is reduced in order to save energy. When the computer operates normally, it is in Normal mode. In this mode, the Power Management Program will control the access to video, parallel ports, serial ports and drives, and the operating status of the keyboard, mouse and other device. These are referred to as Power Management Events. In cases where none of these events occur, the system enters the power saving mode. When one of the controlled events occurs, the system immediately returns to normal mode and operates at its maximum speed. Power saving modes can be divided into three modes according to their power consumption: Doze Mode, Standby Mode, and Suspend Mode. The four modes proceed in the following sequence:

Normal Mode ==>> Doze Mode ==>> Standby Mode ==>> Suspend Mode



The system consumption is reduced according the following sequence:

Normal > Doze > Standby > Suspend

1. In the Main Menu, select "Power Management Setup" and press "Enter". The following screen is displayed:

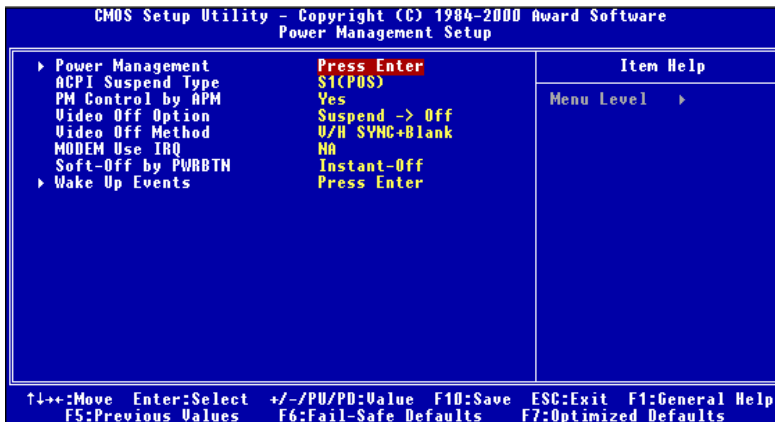

Figure 3-7A. Power Management Setup Main Menu

2. Use the arrow keys to go to the item you want to configure. To change the settings, use **PgUP**, **PgDn**, + or - key.
3. After you have configured the Power Management feature, press **Esc** to go back to the Main Menu.

We are now going to briefly explain the options in this menu:

ACPI Function (Advanced Configuration and Power Interface):

ACPI gives the operating system direct control over the power management and Plug and Play functions of a computer.

The ACPI functions are always “Enabled”. If you want ACPI functions to work normally, you should notice two things. One is your operating system must support ACPI, as of now only Microsoft® Windows® 98 and Windows® 2000 supports these functions. The second thing is that all devices and add-on cards in your system must fully support ACPI, both hardware and software (drivers). If you want to know if your devices or add-on cards support ACPI or not, please contact the device or add-on card manufacture for more information. If you want to know more about ACPI specifications, please go to the address below for more detailed information:

<http://www.teleport.com/~acpi/acpihtml/home.htm>

Note: If you enable the ACPI function in the BIOS setup, the SMI function will not work.

ACPI requires an ACPI-aware operating system. ACPI features include:

- Plug and Play (including bus and device enumeration) and APM functionality normally contained in the BIOS.
- Power management control of individual devices, add-in cards (some add-in cards may require an ACPI-aware driver), video displays, and hard disk drives.
- A Soft-off feature that enables the operating system to power off the computer.
- Support for multiple wake-up events (see Table 3-6-1).
- Support for a front panel power and sleep mode switch. Table 3-6-2 describes the system states based on how long the power switch is pressed, depending on how ACPI is configured with an ACPI-aware operating system.

Note

If you enable the ACPI function in the BIOS setup, the SMI switch function will not work.

System States and Power States

Under ACPI, the operating system directs all system and device power state transitions. The operating system puts devices in and out of low-power states based on user preferences and knowledge of how devices are being used by applications. Devices that are not being used can be turned off. The operating system uses information from applications and user settings to put the system as a whole into a low-power state.

Table 3-6-1: Wake Up Device and Events

The table below describes which devices or specific events can wake the computer from specific states.

These device/events can wake up the computer.....from this state
Power switch	Sleeping mode or power off mode
RTC alarm	Sleeping mode or power off mode
LAN	Sleeping mode or power off mode
Modem	Sleeping mode or power off mode
IR command	Sleeping mode
USB	Sleeping mode
PS/2 keyboard	Sleeping mode
PS/2 mouse	Sleeping mode

Table 3-6-2: Effect of Pressing the Power Switch

If the system is in this state.....and the power switch is pressed forthe system enters this state
Off	Less than four seconds	Power on
On	More than four seconds	Soft off/Suspend
On	Less than four seconds	Fail safe power off
Sleep	Less than four seconds	Wake up

Power Management:

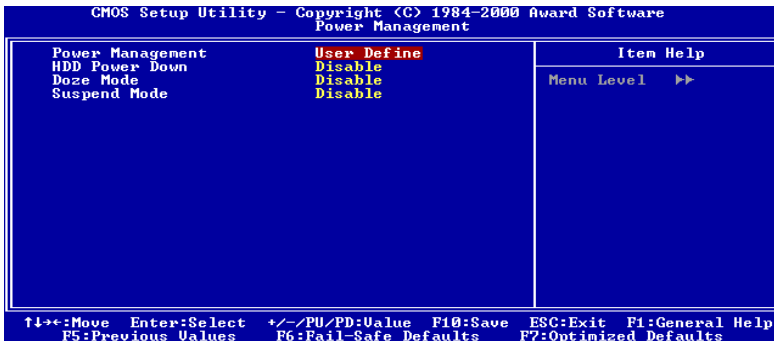

Figure 3-7B. Power Management Setup Menu

This item allows you to select the type (or degree) of power saving and is directly related to the following modes:

1. HDD Power Down
2. Doze Mode
3. Suspend Mode

There are three options for power management, three of which have fixed mode settings:

► User Define

“User Define” defines the delay for accessing the power modes.

HDD Power Down: Disabled → 1 Min → 2 Min → 3 Min → 4 Min → 5 Min → 6 Min → 7 Min → 8 Min → 9 Min → 10 Min → 11 Min → 12 Min → 13 Min → 14 Min → 15 Min. The default setting is *Disabled*.

Doze Mode: Disabled → 1 Min → 2 Min → 4 Min → 6 Min → 8 Min → 10 Min → 20 Min → 30 Min → 40 Min → 1 Hour. The default setting is *Disabled*.

Suspend Mode: Disabled → 1 Min → 2 Min → 4 Min → 6 Min → 8 Min → 10 Min → 20 Min → 30 Min → 40 Min → 1 Hour. The default setting is *Disabled*.

HDD Power Down:

Sixteen items available: Disable → 1 Min → 2 Min → 3 Min → 4 Min → 5 Min → 6 Min → 7 Min → 8 Min → 9 Min → 10 Min → 11 Min → 12 Min → 13 Min → 14 Min → 15 Min → Back to Disable. The default setting is *Disable*.

If the system has not accessed data on the hard disk drive during the specified time period, the engine of the HDD will stop in order to save electricity. You can set 1 to 15 minutes or select Disable according to your use of the HDD.

Doze Mode:

Fifteen items are available: Disabled → 1 Min → 2 Min → 4 Min → 6 Min → 8 Min → 10 Min → 20 Min → 30 Min → 40 Min → 1 Hour → Back to Disable. The default setting is *Disable*.

When the setting selected for "Power Management" is "User Define", you can define for this mode any delay from 1 minute to 1 hour. If no power management event occurs during this time period, meaning that the computer is inactive during this period, the system will enter the Doze power saving mode. If this mode is disabled, the system will enter the next mode in the sequence (suspend mode).

Suspend Mode:

Fifteen items are available: Disabled → 1 Min → 2 Min → 4 Min → 6 Min → 8 Min → 10 Min → 20 Min → 30 Min → 40 Min → 1 Hour → Back to Disable. The default setting is *Disable*.

When the setting selected for "Power Management" is "User Define", you can define for this mode any delay from 1 minute to 1 hour. If no power management event occurs during this time period, meaning the computer is inactive during this period, the system will enter the Suspend power saving mode. The CPU stops working completely.

If this mode is disabled, the system will not enter the suspend mode.

► Min Saving

When these two saving modes are enabled, the system is set up for minimum power savings.

HDD Power Down = 15 Min

Doze Mode = 1 Hour

Suspend Mode = 1 Hour

► Max Saving

When the two saving modes are enabled, the system is set up for maximum power savings.

HDD Power Down = 1 Min

Doze Mode = 1 Min

Suspend Mode = 1 Min

ACPI Suspend Type:

Generally, ACPI has six states: System S0 state, S1, S2, S3, S4, S5. S1 states are described below:

The S1 (POS) State (POS means Power On Suspend):

While the system is in the S1 sleeping state, its behavior is as described below:

- The processor is not executing instructions. The processor's complex context is maintained.
- Dynamic RAM context is maintained.
- Power Resources are in a state compatible with the system S1 state. All Power Resources that supply a System Level reference of S0 are in the OFF state.
- Devices states are compatible with the current Power Resource states. Only devices which solely reference Power Resources which are in the ON state for a given device state can be in that device state. In all other cases, the device is in the D3 (off) state.

- Devices that are enabled to wake the system and that can do so from their current device state can initiate a hardware event which transitions the system state to S0. This transition causes the processor to continue execution where it left off.

To transition into the S1 state, the operating software does not have to flush the processor's cache.

The S3 (STR) State (STR means Suspend to RAM):

The S3 state is logically lower than the S2 state and is assumed to conserve more power. The behavior of this state is defined as follows:

- Processor is not executing instructions. The processor complex context is not maintained.
- Dynamic RAM context is maintained.
- Power Resources are in a state compatible with the system S3 state. All Power Resources that supply a System Level reference of S0, S1, or S2 are in the OFF state.
- Devices states are compatible with the current Power Resource states. Only devices which solely reference Power Resources which are in the ON state for a given device state can be in that device state. In all other cases, the device is in the D3 (off) state.
- Devices that are enabled to wake the system and that can do so from their current device state can initiate a hardware event which transitions the system state to S0. This transition causes the processor to begin execution at its boot location. The BIOS performs initialization of core functions as required to exit an S3 state and passes control to the firmware resume vector. Please see the ACPI Specification Rev. 1.0 book section 9.3.2 for more details on BIOS initialization.

From the software point of view, this state is functionally the same as the S2 state. The operational difference can be that some Power Resources that could be left ON in the S2 state might not be available to the S3 state. As such, additional devices can be required to be in logically lower D0, D1, D2, or D3 state for S3 than S2. Similarly, some device wake events can function in S2 but not S3.

Because the processor context can be lost while in the S3 state, the transition to the S3 state requires that the operating software flush all dirty cache to DRAM.

**** Above information for system S1 were refer to ACPI Specification Rev. 1.0.***

PM Control by APM:

Power Management is completely controlled by the APM.

Two options are available: Yes or No. The default setting is *Yes*. APM stands for Advanced Power Management, it is a power management standard set by Microsoft®, Intel® and other major manufacturers.

Video Off Option:

Select the saving mode in which the video is switched off.

► *Always On*

The video will never be switched off in the "no power saving" mode.

► *Suspend → Off*

The video will only be switched off in Suspend mode. (Default setting)

► *All Modes → Off*

The video will be switched off in all power saving modes.

Video Off Method:

Three video off methods are available: "Blank Screen", "V/H SYNC + Blank" and "DPMS Support". The default is "V/H SYNC + Blank".

If this setting does not shut off the screen, select "Blank Screen". If your monitor and video card support DMPS standard, select "DPMS Support".

Modem Use IRQ:

Eight items available: 3 → 4 → 5 → 7 → 9 → 10 → 11 → NA → Back to 3. The default setting is 3. You can specify the IRQ for modem use.

Soft-Off by PWRBTN:

Two items available: Instant-Off or Delay 4 Sec. The default setting is *Instant-Off*. It is activated when the user presses the power button for more than four seconds while the system is in the working state, then the system will transition to the soft-off (Power off by software). This is called the power button over-ride.

Wake Up Events:

When one of the specified events occurs, the count down for entry into the power saving mode goes back to zero. Since the computer will enter a power saving mode only after a specified inactivity delay (time specific for Doze, Standby and Suspend modes) and after there has been no activity during this time period, any event will cause the computer to re-count the time elapsed. Resume events are operations or signals that cause the computer to resume time counting.

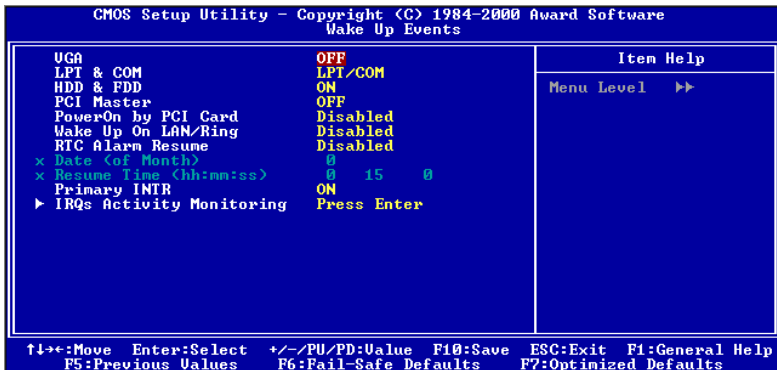

Figure 3-7C. Wake Up Events Setup Menu

► **VGA:**

Two items available: On or Off. The default setting is *Off*. When set to On, any event occurring at a VGA port will awaken a system, which has been powered down.

► **LPT & COM:**

Four items available: LPT/COM → None → LPT → COM. The default setting is *LPT/COM*. When set to LPT/COM, any event occurring at a LPT (printer)/COM(serial) port will awaken a system which has been powered down.

► **HDD & FDD:**

Two items available: On or Off. The default setting is *On*. When set to On, any event occurring at a hard disk drive or floppy drive port will awaken a system, which has been powered down.

► **PCI Master:**

Two items available: On or Off. The default setting is *Off*. When set to On, any event occurring at PCI Master signal will awaken a system, which has been powered down.

► **PowerOn by PCI Card:**

Two items available: Disabled or Enabled. The default setting is *Disabled*. When set to Enabled, any event occurring to the PCI card will awaken a system, which has been powered down.

► **Wake UpOn LAN/Ring :**

Two items available: Disabled or Enabled. The default setting is *Disabled*. When set to Enabled, any event occurring to the LAN or modem ring will awaken a system, which has been powered down.

► **RTC Alarm Resume:**

Two items available: Disabled or Enabled. The default setting is *Disabled*. When *Enabled*, you can set the date and time at which the RTC (real-time clock) alarm awakens the system from Suspend mode.

— **Date (of Month) / Resume Time (hh:mm:ss):**

You could set the **Date (of month)** and **Resume time (hh:mm:ss)**, any event occurring at will awaken a system, which has been powered down.

Primary INTR:

Two items available: On or Off. The default setting is *On*. When set to On, any event occurring at below list will awaken a system which has been powered down.

IRQs Activity Monitoring

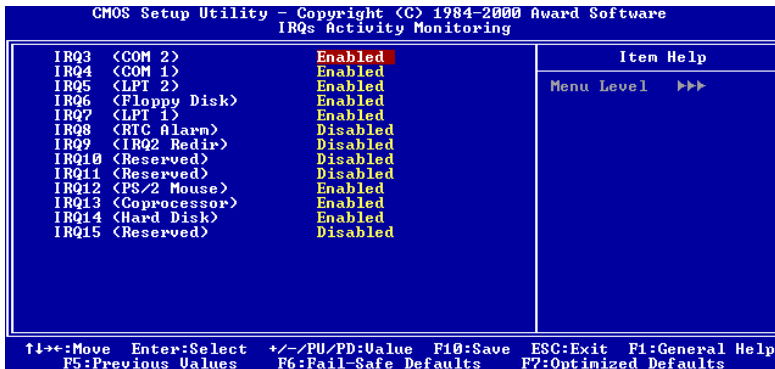

Figure 3-7D. IRQs Activity Monitoring Setup Menu

The following is a list of IRQ's, Interrupt **Re**Quests, which can be exempted much as the COM ports and LPT ports above can. When an I/O device wants to gain the attention of the operating system, it signals by causing an IRQ to occur. When the operating system is ready to respond to the request, it interrupts itself and performs the service.

As above, the choices are On and Off.

When set On, activity will neither prevent the system from going into a power management mode nor awaken it. Each item has two options: Enabled → Disabled.

- ▶ IRQ3 (COM 2): The default setting is *Enabled*.
- ▶ IRQ4 (COM 1): The default setting is *Enabled*.
- ▶ IRQ5 (LPT 2): The default setting is *Enabled*.
- ▶ IRQ6 (Floppy Disk): The default setting is *Enabled*.
- ▶ IRQ7 (LPT 1): The default setting is *Enabled*.
- ▶ IRQ8 (RTC Alarm): The default setting is *Disabled*.
- ▶ IRQ9 (IRQ2 Redir): The default setting is *Disabled*.
- ▶ IRQ10 (Reserved): The default setting is *Disabled*.
- ▶ IRQ11 (Reserved): The default setting is *Disabled*.
- ▶ IRQ12 (PS/2 Mouse): The default setting is *Enabled*.
- ▶ IRQ13 (Coprocessor): The default setting is *Enabled*.
- ▶ IRQ14 (Hard Disk): The default setting is *Enabled*.
- ▶ IRQ15 (Reserved): The default setting is *Disabled*.

3-7. PNP/PCI Configurations Setup Menu

In this menu, you can change the INT# and IRQ of the PCI bus and other hardware settings.

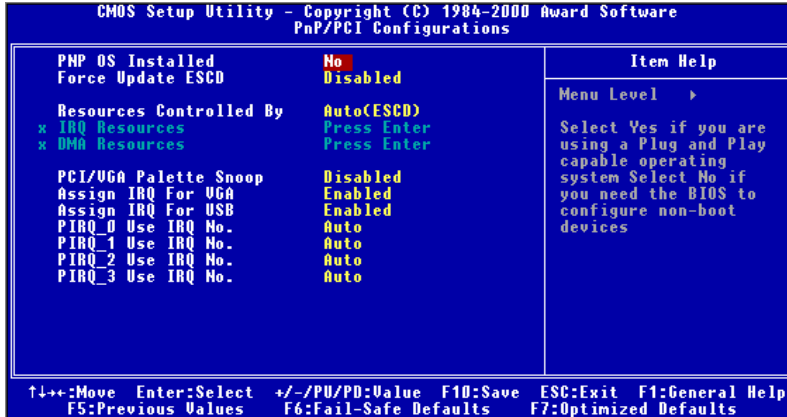

Figure 3-8A. PNP/PCI Configurations Setup Menu

PNP OS Installed:

Device resource assigned by PnP OS or BIOS.

Force Update ESCD:

Two options are available: Disabled or Enabled. The default setting is *Disabled*. Normally, you leave this field Disabled. Select Enabled to reset Extended System Configuration Data (ESCD) when you exit Setup if you have installed a new add-on and the system reconfiguration has caused such a serious conflict that the operating system cannot boot.

Computer Knowledge: ESCD (Extended System Configuration Data)

The ESCD contains the IRQ, DMA, I/O port, memory information of the system. This is a specification and a feature specific to the Plug & Play BIOS.

Resources Controlled By:

When resources are controlled manually, assign each system interrupt as one of the following types, depending on the type of device using the interrupt:

KT7/KT7-RAID/KT7A/KT7A-RAID

Legacy ISA devices compliant with the original PC AT bus specification, requiring a specific interrupt (such as IRQ4 for serial port 1).

PCI/ISA PnP devices compliant with the Plug and Play standard, whether designed for the PCI or ISA bus architecture.

Two options are available: Auto(ESCD) or Manual. The default setting is *Auto(ESCD)*. The Award Plug and Play BIOS has the capability to automatically configure all of the boot and Plug and Play compatible devices. If you select Auto(ESCD), all of the interrupt request (IRQ) and DMA assignment fields disappear, as the BIOS automatically assigns them. But if you have trouble in assigning the interrupt resource automatically, you can select Manual to set which IRQ and DMA are assigned to PCI/ISA PnP or legacy ISA cards.

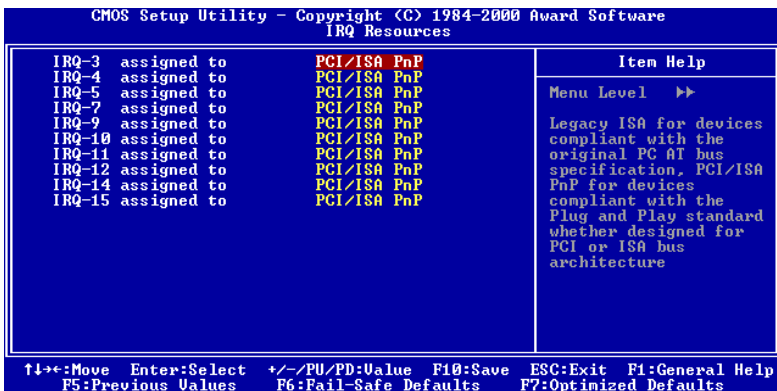

Figure 3-8B. IRQ Resources Setup Menu

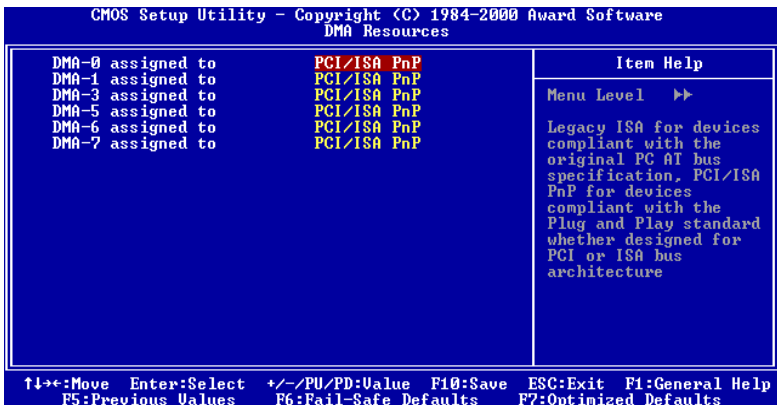

Figure 3-8C. DMA Resources Setup Menu

PCI/VGA Palette Snoop:

This option allows the BIOS to preview VGA Status, and to modify the information delivered from the Feature Connector of the VGA card to the MPEG Card. This option can solve the display inversion to black after you have used the MPEG card.

Assign IRQ For VGA:

Two options are available: Disabled or Enabled. The default setting is *Enabled*. Name the interrupt request (IRQ) line assigned to the USB/VGA/ACPI (if any) on your system. Activity of the selected IRQ always awakens the system.

You can assign an IRQ for the PCI VGA or *Disabled*.

Assigned IRQ For USB:

Two options are available: Disabled or Enabled. The default setting is *Enabled*. If you need another IRQ to be freed up, you can choose to disable this item, and you can get an IRQ. But in some situations in Windows® 95 it may cause the USB port to malfunction or have other problems! Two options are available: Enable or Disable.

PIRQ_0 Use IRQ No. ~PIRQ_3 Use IRQ No.:

Eleven options are available: Auto, 3, 4, 5, 7, 9, 10, 11, 12, 14, 15. Default setting is *Auto*. This item allows the system to automatically specify the IRQ number for the device installed on PCI slots. Which means, the system can specify the fixed IRQ number for the device installed on the PCI slots (PCI slot 1 to PCI slot 6). This is a useful function when you want to fix the IRQ for a specific device.

For example, if you want to move your hard disk to another computer and don't want to re-install Windows® NT, then you can specify the IRQ for the device installed on the new computer to fit the original computer settings.

Note

If you specify the IRQ in this item, then you cannot specify the same IRQ to the ISA bus, otherwise, it will cause a hardware conflict.

This feature is for the operating system which will record and fix the PCI configuration status, if you want to change it.

For the relations between the hardware layout of PIRQ (the signals from the VIA VT82C686A chipset), INT# (means PCI slot IRQ signals) and devices, please refer to the table below:

SIGNALS	PCI Slot 1	PCI Slot 2	PCI Slot 3	PCI Slot 4	PCI Slot 5	PCI Slot 6
PIRQ 0 Assignment	INT A	INT B	INT B	INT D	INT C	INT D
PIRQ 1 Assignment	INT B	INT D	INT A	INT A	INT D	INT B
PIRQ 2 Assignment	INT C	INT C	INT D	INT B	INT A	INT C
PIRQ 3 Assignment	INT D	INT A	INT C	INT C	INT B	INT A

- USB used INT D.
- Each PCI slot has four INT#s (INT A~INT D), and the AGP slot has two INT# (INTA and INT B).

Note

- PCI slot 1 shares IRQ signals with the AGP slot.
- PCI-4 and USB controllers share an IRQ.
- If you want to install two PCI cards into those PCI slots that share IRQ with one another at the same time, you must make sure that your OS and PCI devices' driver support IRQ sharing function.
- PCI slot 5 shares IRQ signals with the HPT370 IDE controller (supports Ultra ATA/100). The driver for HPT 370 IDE controller supports IRQ sharing with other PCI devices. But if you install a PCI card that doesn't allow IRQ sharing with other devices into PCI slot 5, you may encounter some problems. Furthermore, if your Operating System doesn't allow peripheral devices to share IRQ signals with each other, such as Windows® NT for example, you can't install a PCI card into PCI slot 5. **(KT7-RAID & KT7A-RAID Only)**
- HPT 370 IDE controller is designed to support high-speed and high performance mass storage devices. Thus we suggest that you don't connect non-disk devices that use ATA/ATAPI interfaces, such as CD-ROM to HPT 370 IDE connector (IDE3 & IDE4). **(KT7-RAID & KT7A-RAID Only)**

3-8. PC Health Status

You can set the warning and shutdown temperatures for your computer system, and you can check the fan speeds and power supply voltages of your computer system. The features are useful for monitoring all the important parameters within your computer system. We call it the *PC Health Status*.

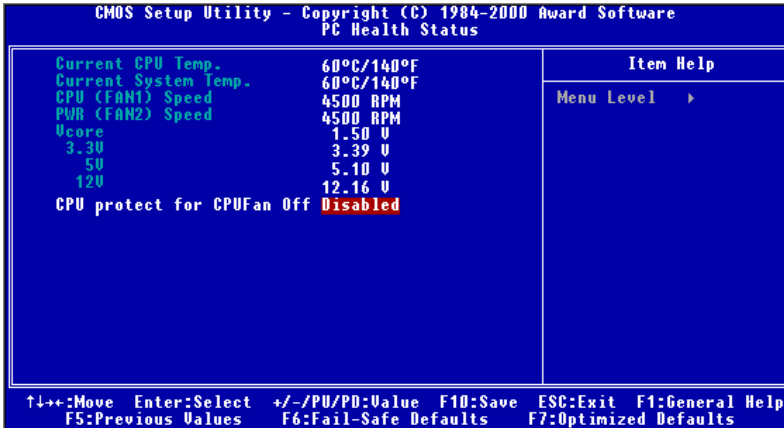

Figure 3-9. PC Health Status Screen Shot

All Voltages, Fans Speed and Thermal Monitoring:

These items list the current states of the CPU and environment (using TCPU1 and TSYS1 to detect them.) temperatures as well as fan speeds (CPU fan and chassis fan). It can not be changed by the user.

The following items list the voltage states of the system power. It is also unchangeable.

CPU protect for CPUFan Off:

Two options are available: Disabled or Enabled. The default setting is *Disabled*. When you set to the Enabled, if the CPU fan is not rotating, the system will immediately shutdown until you replace or repair the CPU fan.

This item can let the BIOS detect whether the processor fan is rotating or not. If the CPU fan is not rotating when the system boots, the BIOS will force the system to shutdown. If the CPU fan is working well, the system will operate normally. If the CPU fan suddenly stops

rotating during use, the BIOS is unable to shutdown the system. Therefore, it is still best to use another application which can monitor and shutdown the system under the operating system. The BIOS only monitors this situation under the boot sequence.

Note

The hardware monitoring features for temperatures, fans and voltages will occupy the I/O address from 294H to 297H. If you have a network adapter, sound card or other add-on cards that might use those I/O addresses, please adjust your add-on card I/O address, to avoid the use of those addresses.

3-9. Load Fail-Safe Defaults

When you press <Enter> on this item you get a confirmation dialog box with a message similar to:

Load Fail-Safe Defaults (Y/N)? **N**

Pressing 'Y' loads the BIOS default values for the most stable, minimal-performance system operations.

3-10. Load Optimized Defaults

When you press <Enter> on this item you get a confirmation dialog box with a message similar to:

Load Optimized Defaults (Y/N)? **N**

Pressing 'Y' loads the default values that are factory settings for optimal performance system operations.

3-11. Set Password

Set Password: Can enter but do not have the right to change the options of the setup menus. When you select this function, the following message will appear at the center of the screen to assist you in creating a password.

ENTER PASSWORD:

Type the password, up to eight characters in length, and press <Enter>. The password typed now will clear any previously entered password from CMOS memory. You will be asked to confirm the password. Type the password again and press <Enter>. You may also press <Esc> to abort the selection and not enter a password.

To disable a password, just press <Enter> when you are prompted to enter the password. A message will confirm the password will be disabled. Once the password is disabled, the system will boot and you can enter Setup freely.

PASSWORD DISABLED.

When a password has been enabled, you will be prompted to enter it every time you try to enter Setup. This prevents an unauthorized person from changing any part of your system configuration.

Additionally, when a password is enabled, you can also require the BIOS to request a password every time your system is rebooted. This would prevent unauthorized use of your computer.

You determine when the password is required within the BIOS Features Setup Menu and its Security option. If the Security option is set to "System", the password will be required both at boot and at entry to Setup. If set to "Setup", prompting only occurs when trying to enter Setup.

3-12. Save & Exit Setup

Pressing <Enter> on this item asks for confirmation:

Save to CMOS and EXIT (Y/N)? **Y**

Pressing “Y” stores the selections made in the menus in CMOS - a special section of memory that stays on after you turn your system off. The next time you boot your computer, the BIOS configures your system according to the Setup selections stored in CMOS. After saving the values the system is restarted again.

3-13. Exit Without Saving

Pressing <Enter> on this item asks for confirmation:

Quit without saving (Y/N)? **Y**

This allows you to exit Setup without storing in CMOS any change. The previous selections remain in effect. This exits the Setup utility and restarts your computer.



Chapter 4. RAID Setting Guide

For detail RAID introduce and concept, you can found it on our WEB site “**Technological Terms**”, or you can search the concerning information on internet. We do not description it on this manual.

4-1. The features of RAID on the KT7-RAID/KT7A-RAID

The KT7-RAID/KT7A-RAID supports Striping (RAID 0), Mirroring (RAID 1), or Striping/Mirroring (RAID 0+1) operation. For the striping operation, the identical drives can read and write data in parallel to increase performance. The Mirroring operation creates a complete backup of your files. Striping with Mirroring operation offers both high read/write performance and fault tolerance although requiring 4 hard disks in order to do so.

4-2. RAID SETUP on the KT7-RAID/KT7A-RAID

Enter Advanced BIOS Features in the BIOS setup. Change the settings of first Boot Device, Second Boot Device and Third Boot Device to read ATA-100. See Figure 4-1

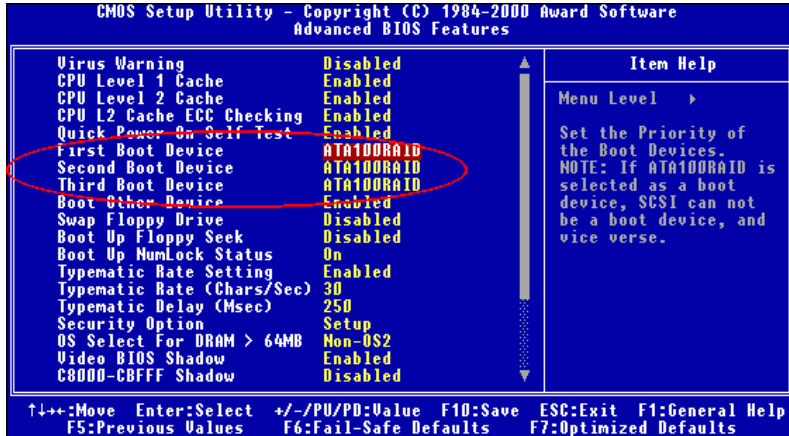

Figure 4-1. RAID settings in BIOS

4-3. The BIOS Setting Menu

Reboot your system. Press <CTRL> and <H> key while booting up the system to enter the BIOS setting menu. The main menu of BIOS Setting Utility appears as shown below:

```

HPT3xx  <BIOS Setting Utility>

Menu
1. Create RAID
2. Delete RAID
3. Duplicate Mirror Disk
4. Set Drive Mode
5. Select Boot Disk

Help
Create a RAID Array with the
hard disks attached to the
HPT3xx

F1:   View Array Status
T,I:  Move to next item
Enter: Confirm the selection
Esc:  Return to top menu

Channel Status
Channel      Drive Name      Mode  Size(M)  Status
Primary Master  QUANTUM FIREBALL CR4.3  UDMA4  4209  HDD0
Primary Slave   No Drive
Secondary Master QUANTUM FIREBALL CR4.3  4209  HDD1
Secondary Slave No Drive

(C)1999-2000. HighPoint Technologies, Inc.
All rights reserved

```

For selecting the option in the menu, you may:

- Press **F1** to view array status.
- Press **↑ ↓** (up, down arrow) to choose the option you want to confirm or to modify.
- Press **Enter** to confirm the selection.
- Press **Esc** to return to top menu.

NOTE

If you want to create a RAID 0 (striping) array or RAID 0+1 array, all data in your hard disk will first be erased! Please backup the hard disk data before starting to create these RAID arrays. If you want to create a RAID 1 (mirroring) array, please be sure which hard disk is the source disk and which one is the destination disk. If you make a mistake, you may copy the blank data to the source disk, which will result in both hard disks becoming blank!

4-3-1. OPTION 1: Create RAID

This item allows you to create a RAID array.

After you had selected the function you want in the main menus, you may press the <Enter> key to enter the sub menu as shown below:

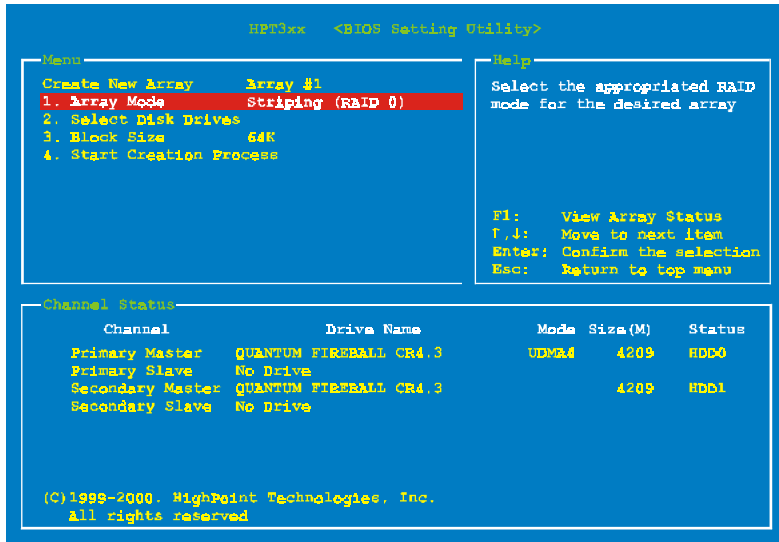

Array Mode:

This item allows you to select the appropriate RAID mode for the desired array. There are four modes to choose.

Note

It is highly recommended to attach hard disks with the same brand and same model in reaching the RAID performance.

- *Striping (RAID 0)*:
This item is recommended for high performance usage. Requires at least 2 disks.
- *Mirror (RAID 1)*:
This item is recommended for data security usage. Requires at least 2 disks.

— *Striping and Mirror (RAID 0+1):*

This item is recommended for data security and high performance usage. Allows Mirroring with a Strip Array. Require four drivers only.

— *Span (JBOD):*

This item is recommended for high capacity without redundancy or performance features usage. Requires at least 2 disks.

Note

When you choose to create RAID 1 and your source disk is not empty. You have to do the **Duplicate Mirror Disk** to make whole data copy to the destination disk. Otherwise, it will only copy the partition table to the destination disk, not physical data.

Select Disk Drives:

This item allows you to select the disk drives to be used with the RAID array.

Block Size:

This item allows you to select the block size of the RAID array. There are five options: 4K, 8K, 16K, 32K, and 64K.

Start Creation Process:

After you have made your selection, choose this item and press <Enter> to start creation.

4-3-2. OPTION 2: Delete RAID

This item allows you to remove a RAID Array on this IDE RAID controller card.

Note: After you have made and confirmed this selection, all the data stored in the hard disk will be lost. (The entire partition configuration will be deleted too.)

4-3-3. OPTION 3: Duplicate Mirror Disk

This item allows you to select the disk you wish to duplicate in preparation for a “Mirror Disk Array”.

After you have selected the function you want in the main menu, you may press the <Enter> key to enter the sub menu as shown below:

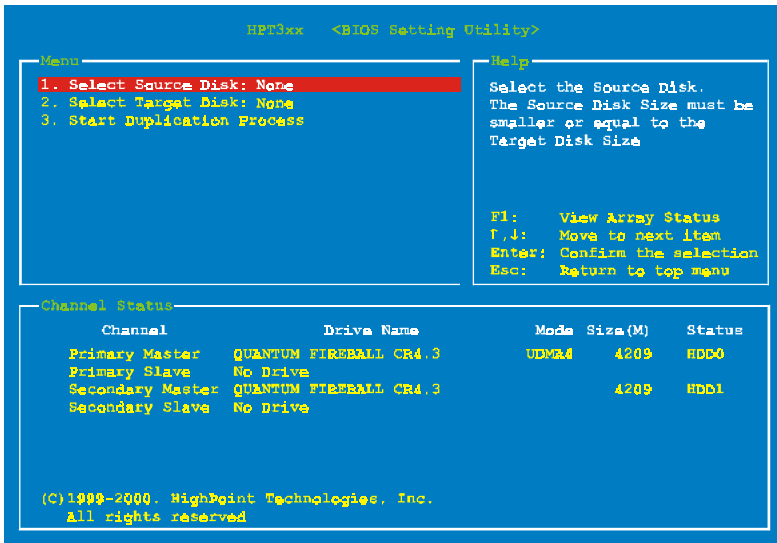

- *Select Source Disk:*
This item is to select the source disk. **The size of source disk must be smaller or equal to the one of target disk.**
- *Select Target Disk:*
This item is to select the target disk. The size of target disk must be greater or equal to the one of source disk.
- *Start Duplicating Process:*
After you had selected this item, the BIOS setting will take up to 30 minutes to run the duplication. Please wait or you may press <Esc> to cancel.

4-3-4. OPTION 4: Set Drive Mode

This item allows you to select the drive transfer mode for the hard disk(s).

Use the up/down arrow to select the menu option to “Set Drive Mode” and press <Enter>. In the Channel Status, select the channel you would like to set and press <Enter>, there will come out an asterisk mark in the parentheses indicating that the channel selection had been done. Choose the mode from the pop-up menu. You can choose from PIO 0 ~ 4, MW DMA 0 ~ 2, and UDMA 0 ~ 5.

4-3-5. OPTION 5: Select Boot Disk

This item allows you to select the boot disk among the hard disk(s).

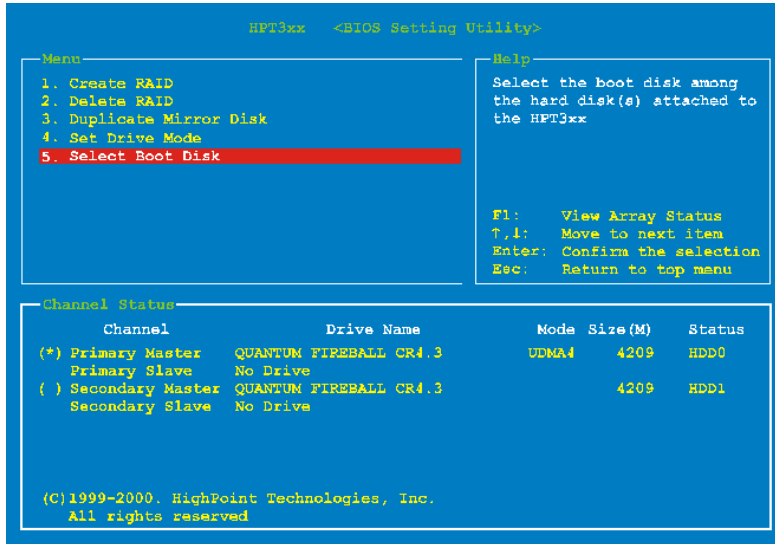

Use the up/down arrow to select the menu option to “Select Boot Disk” and press <Enter>. In the Channel Status, select the channel you would like to set as bootable disk and press <Enter>, there will come out an asterisk mark in the parentheses indicating that the channel selection had been done.

Chapter 5. HPT370 Software Installation

Here we will show you the driver installation procedure under various operating systems.

5-1. DOS[®]

This IDE RAID BIOS supports DOS[®] 5.x (or above) and Windows[®] 3.1x without the software driver.

5-2. Windows[®] 9x

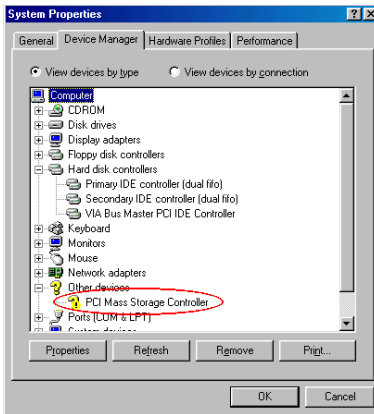

Step 1: After the Windows[®] 9x operating system had been installed and rebooted successfully, go to the “Control Panel” → “System Properties” → “Device Manager”. You can see the driver is not yet installed, and there is a device of “PCI Mass Storage Controller” under “Other devices”.

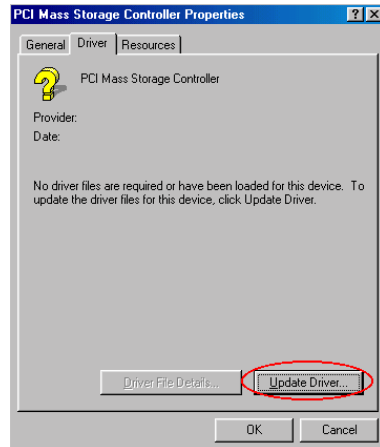

Step 2: Click right button of your mouse on the “? PCI Mass Storage Controller”, and then go to “Driver” tab. Click “Update Driver” to go to next step.



Step 3: The wizard is going to install the PCI Mass Storage Controller. Click “**N**ext >” to go to next step.

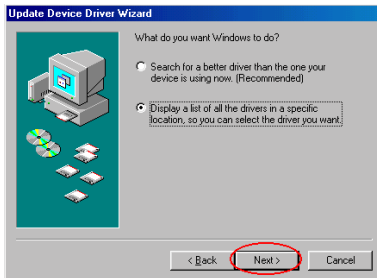

Step 4: Choose “**D**isplay a list of all the drivers in a specific location...” and click “**N**ext >” to go on.

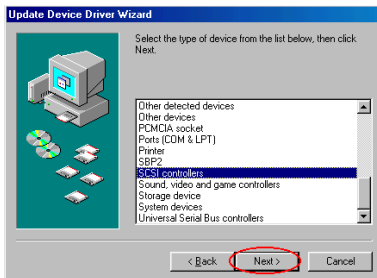

Step 5: Choose “**S**CSI controllers” and click “**N**ext >” to go on.

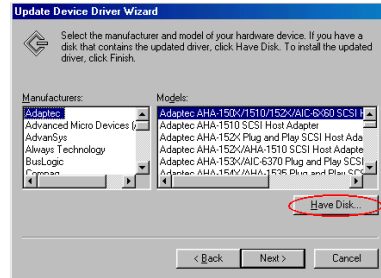

Step 6: Click “**H**ave Disk...” to go on.



Step 7: Insert the driver disk and type the path in the text box “**a:\WIN**” (“**a:**” is your floppy drive letter), or “**D:\Drivers\hpt370\Win9x**” (**D:** is your CD-ROM drive letter).

Click “**O**K” to go on.

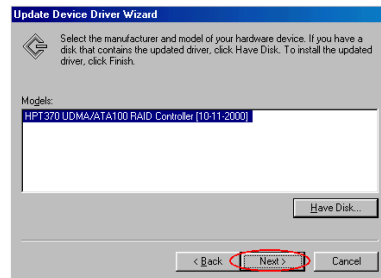

Step 8: Choose “**H**PT370 UDMA/ATA100 RAID Controller” and click “**N**ext >” to go on.



Step 9: Windows is now ready to install the driver. Click **“Next >”** to go on.

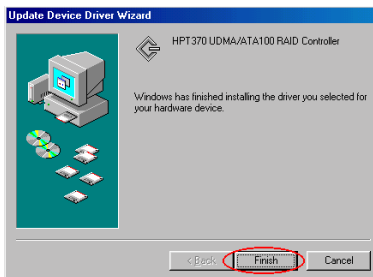

Step 10: Windows has finished installing the driver. Click **“Finish”** to end the installation.

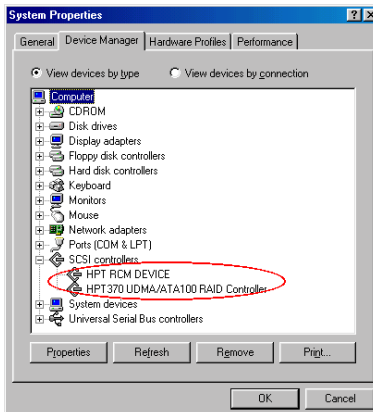

Step 11: After rebooting the system, go to the **“Control Panel”** → **“System Properties”** → **“Device Manager”**. Now

you can see the driver is installed under the item of **“SCSI controllers”**.



Or you can insert the KT7/KT7-RAID/KT7A/KT7A-RAID CD-Title into your CD-ROM drive, it should execute the program automatically. If not, you can go to the CD location and execute the execution file at the main directory of this CD-Title. After it has been executed you will see the screen below. Move the cursor to the **“Drivers”** and click on it. This will take you to the next screen.



Step 1: Move the cursor to **“HPT370 Driver for KT7(A)-RAID”** and click on it. Go to the next screen.



Step 2: Move the cursor to "**Windows 9X/ME**" and click on it. Go to the next screen.



Step 3: Now you will see the install shield loading.

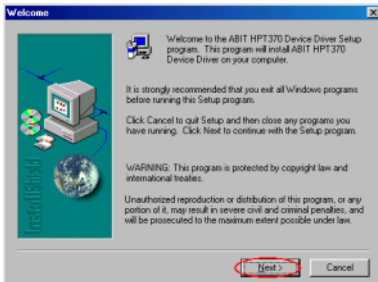

Step 4: You will now see the welcome screen and its dialogue box. Click "**Next >**" to start install drivers.

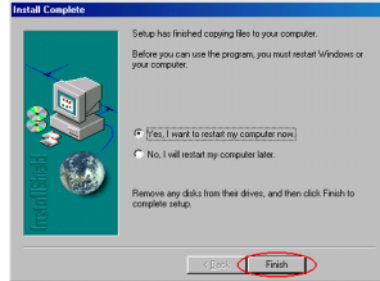

Step 5: When the installation is complete, the installer will ask you to restart your computer. We suggest that you choose "**Yes, I want to restart my computer now**" then click the "**Finish**" button to restart your computer to finish the driver updates.

When system reboot, it will starting update several driver, you just follow the instruction on screen and click "Next" button, then you can finish the process and reboot again.

After reboot, your HPT370 driver will successfully installed.

5-3. Windows NT[®] 4.0

Note

- Before you start to install Windows[®] NT 4.0, you have to create a driver disk for the Hot Rod 100 Pro. You can copy the Ultra ATA/100 driver files from the CD-Title that comes with this motherboard. The path for the Ultra DMA/100 driver files is “E:\drivers\hpt370\nt”. (E is your CD-ROM drive letter)
- Please note two things before you copy the driver files to diskette. Firstly, the driver files must be copied to the root directory of the diskette. Secondly, you have to set your system to “Show all files”. Otherwise you will be unable to copy some important system files to diskette.

Installing drivers during Windows[®] NT installation

If the NT 4.0 is first installed on the ATA100 drive connected to the KT7-RAID/KT7A-RAID motherboard, follow the following installation procedure:

Step 1: Set your system to boot from “Drive A” and then insert the Windows[®] NT installation diskette 1/3. Power on your computer.

Installation Note

If you are installing NT 4.0 from a CD-ROM, please **press the “F6” key** immediately when the message “Setup is inspecting your computer’s hardware configuration...” appears. Then press “S” to configure an additional adapter.

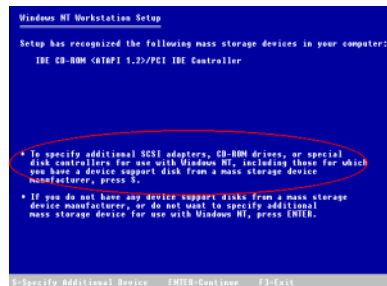

Step 2: The setup program will display a message about installing mass storage devices (see figure left) while you install NT4.0. Please press “S” to install the hpt370 driver

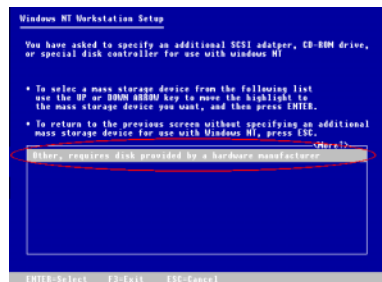

Step 3: Select “Other, requires disk provided by a hardware manufacturer”, and then press <ENTER>.

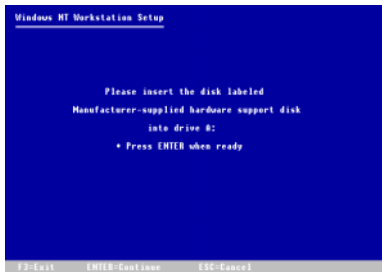

Step 4: Insert the driver disk into drive A and press <ENTER>.

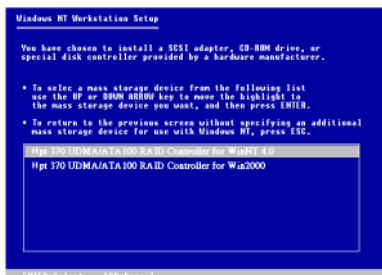

Step 5: Use the UP or DOWN arrow key to move the highlight to the mass storage device you want and press <ENTER> to continue setup.

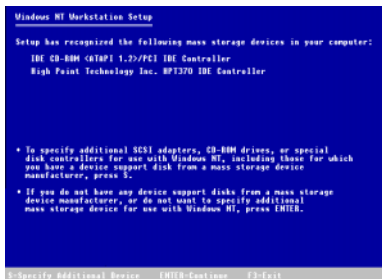

Step 6: Windows® NT setup has recognized this hpt 370 IDE RAID controller

Press <ENTER> to continue setup.

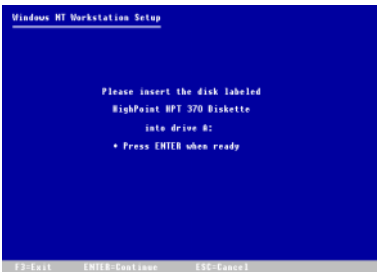

Step 7: After you configure your hard disk and specify the installation path, the NT setup will ask you to insert this hpt 370 IDE RAID controller driver disk into drive A again. Insert the driver disk, and then press <ENTER> to continue setup.

If you have followed the steps described above, you should be finished installing your hpt 370 controller. For the rest of Windows® NT installation steps, please follow the instructions displayed in the NT setup program.

Installing drivers with existing Windows® NT:

If there is an existing NT 4.0 file system, you can install the hpt 370 IDE RAID controller into the existing system by the following procedure:

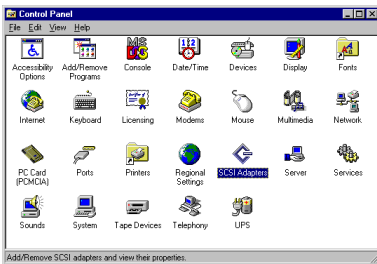

Step 1: Go to “Control Panel”, and then enter “SCSI Adapters”.

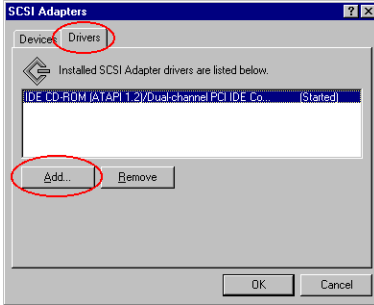

Step 2: Select “Drivers”, and then click “Add...”.

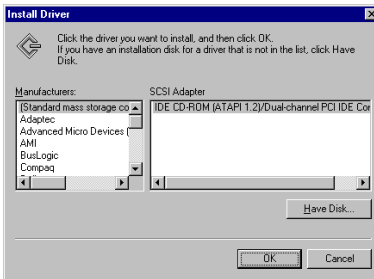

Step 3: Click “Have Disk...” to go on.

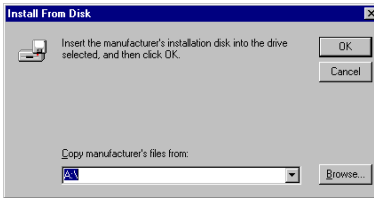

Step 4: Insert this hpt 370 IDE RAID controller driver disk into drive A, and

then click “OK”.

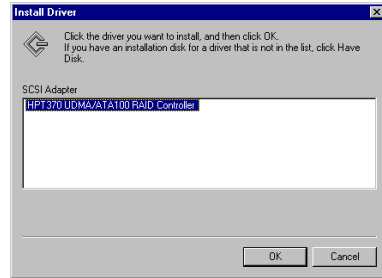

Step 5: Click “OK” to go on.

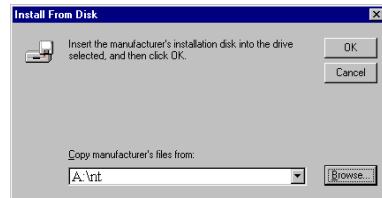

Step 6: Insert the driver disk and type the path in the text box “A:\nt” (“a:\” is your floppy drive letter), or “E:\Drivers\hpt370\nt” (E:\ is your CD-ROM drive letter).

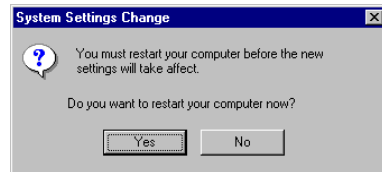

Step 7: Click “Yes” to restart your computer.

5-4. Windows® 2000

Note

If you want to install the Windows® 2000 operating system on the hard drive utilising the hpt 370 controller, please refer to the NT4.0 installation procedure. The following procedure is used only when you don't want to install the Windows® 2000 operating system onto the hard drive utilising the hpt 370 controller.



Step 1: Reboot the system. Windows will detect the new hardware automatically.

Click “Next>” to go to the next step.



Step 2: Choose “Display a list of all the

drivers in a specific location...” and click “Next >” to go on.

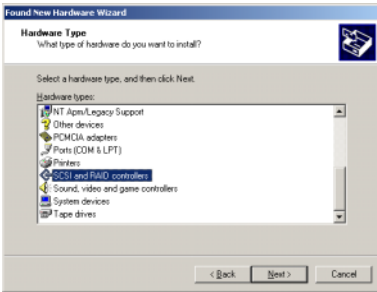

Step 3: Choose “SCSI and RAID controllers” and click “Next >” to go on.

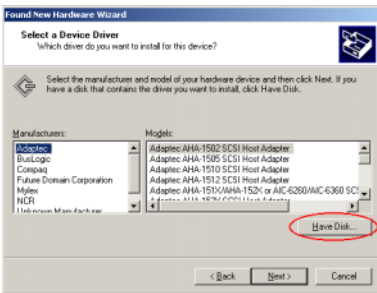

Step 4: Click “Have Disk...” to go on.

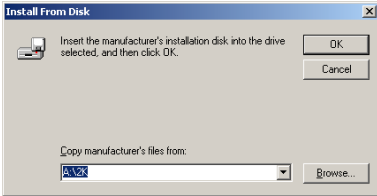

Step 5: Insert the driver disk that comes with the Hot Rod 100 Pro and type the path in the text box “A:\2K” (“a:\” is your floppy drive letter), or “E:\Drivers\hpt370\Win2k” (E:\ is your

CD-ROM drive letter).

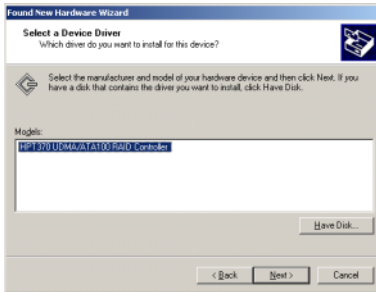

Step 6: Choose “**HPT370 UDMA/ATA100 RAID Controller**” and click “**Next >**” to go on.

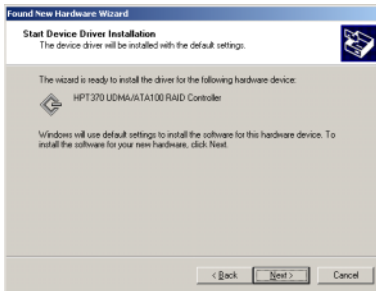

Step 7: Windows is now ready to install the driver. Click “**Next >**” to go on.

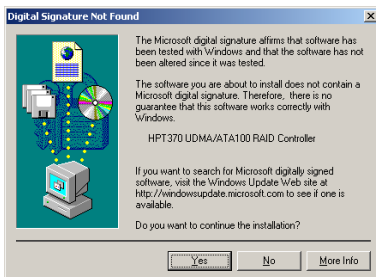

Step 8: Click “**Yes >**” to go on.

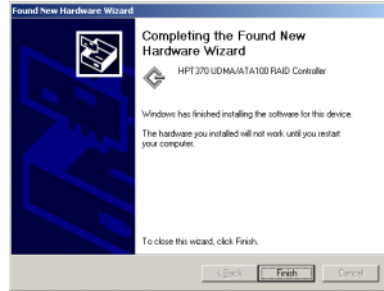

Step 9: Windows has finished installing the driver. Click “**Finish**” to end the installation.

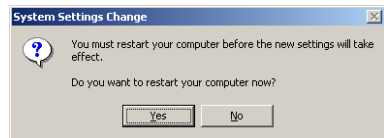

Step 10: Click “**Yes**” to restart the system.

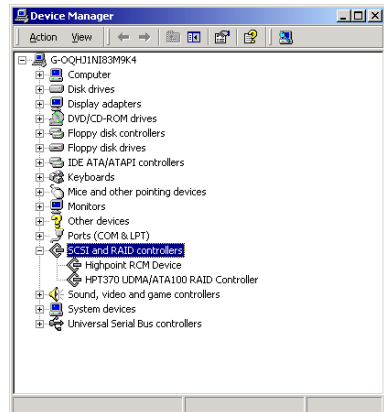

Step 11: Go to the “**Control Panel**” → “**System Properties**” → “**Device Manager**”. Now you can see the driver is installed under the item of “**SCSI and RAID controllers**”.

5-5. HPT370 Utility Installation Guide

In order to provide you with the on-screen monitoring function about the device information of disk array, you may install the “**HPT370 Utility**” onto your system. Please insert the KT7/KT7-RAID/KT7A/KT7A-RAID CD-Title into your CD-ROM drive. It should execute the program automatically. If not, you can go to the CD location and execute the execution file from the main directory of the CD-Title. After it is executed, you will see the screen shot below.



Step 1: Move the cursor to “**Drivers**” and click on it to go to the next step.



Step 3: Move the cursor to “**HPT370 Utility**” and click on it to go to the next step.



Step 2: Move the cursor to “**HPT370 Driver for KT7(A)-RAID**” and click on it to go to the next step.

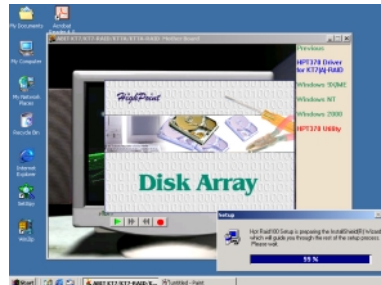

Step 4: Now you will see the install shield loading.

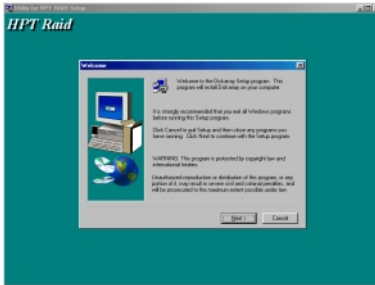

Step 5: You will now see the welcome screen and its dialogue box. Click "**Next**>" to go on.

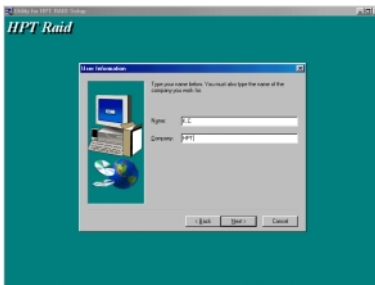

Step 6: Type in the information of your name and company and then click "**Next**>" to go on.

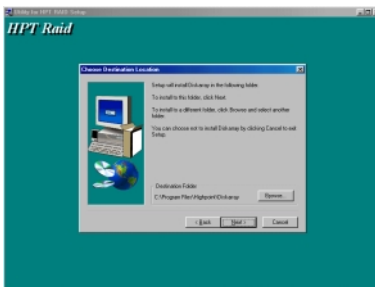

Step 7: Now you can choose the folder for the destination location you want. We suggest you use the default folder as the destination location. When you are sure of the folder, click "**Next**>" to go on.

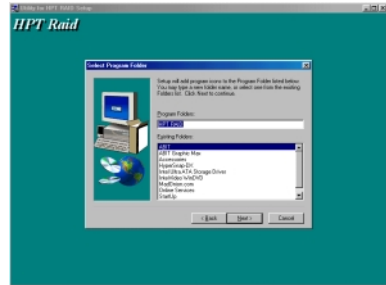

Step 8: Now you can select the program folder. The setup wizard will add program icons to those program folders listed. Click "**Next**>" to go on.

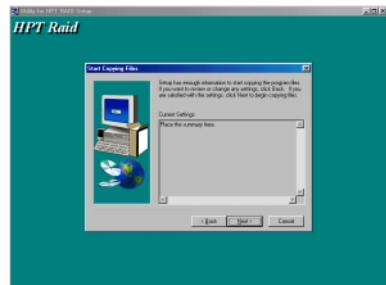

Step 9: The system will start copying files. Click "**Next**>" to go on.

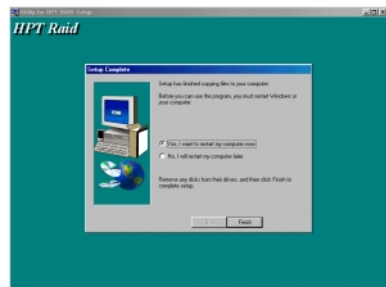

Step 10: When the installation is completed, choose "**Yes, I want to restart my computer now.**" In the check box and click "**Finish**" to end the setup.

Step 11: After the system restart, you can run this “**Stripe & Mirror Settings**” monitoring program.



Step 12: Move the cursor to where the execution file is, shown left.

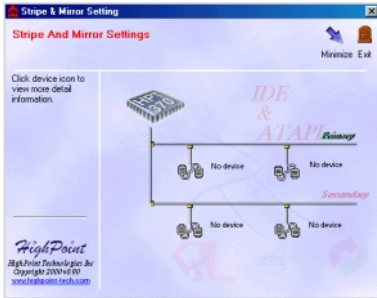

The monitoring screen pops up. Note that there will be a shortcut icon appears in the tool bar. This is used for bringing out the screen again after you had clicked the “**Minimize**” icon on the upper right corner of the screen. This short cut icon will disappear after you click the “**Exit**” icon.

Now you are in the monitoring screen. Your current device allocation is viewable at a glance. Move the cursor to the drive icon you want to view and click on it.

Appendix A VIA Service Pack Drivers Installation for Windows® 98 SE

After you've installed Windows® 98 SE, you need to install the VIA Service Pack drivers. We will tell you step by step in the following section how to do this.

Note

You have to install the VIA Service Pack drivers before you install the VGA and audio drivers. After installing Windows® 98 SE the quality of your display will be poor because it will be set to 640*480 and 16 color. For the best screen capture quality, install the VGA drivers and set the desktop to 800*600 using True Color.

Note

Details of the Windows® 98 SE operating system will not be mentioned in this manual. If you have any problems with Windows® 98 SE installation, operations and settings please refer to your Windows® 98 SE user's manual or other databases provided by Microsoft® Corporation.

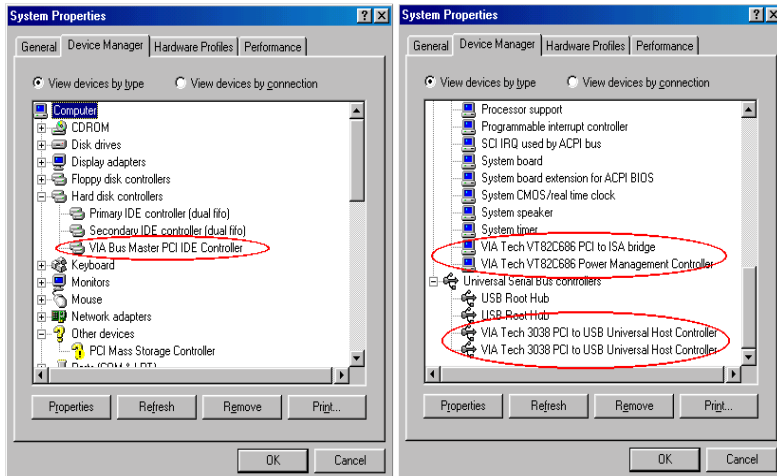

First, go to check the **System Properties** → **Device Manager**. We will show you several places that identify the VIA chipset and controller. Some items will illicit questions.

Exit the device manager and insert the K T7/KT7-RAID/K T7A/KT7A-RAID CD-Title into your CD-ROM drive, it should execute the program automatically. If not, you can go to the CD location and execute the execution file at the main directory of this CD-Title. After it has been executed you will see the screen below.



Step 1: Move the cursor to "Drivers" and click on it. You will go to the next screen.



Step 2: Move the cursor to "VIA Chipset Driver" and click on it. Go to the next screen.



Step 3: Move the cursor to "VIA Service Pack" and click on it. Go to the next

screen.

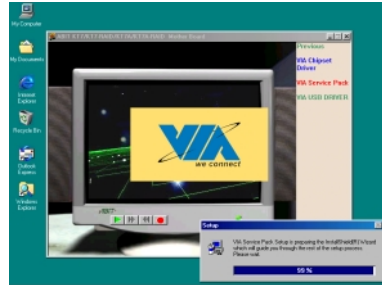

Step 4: Now you will see the install shield loading.

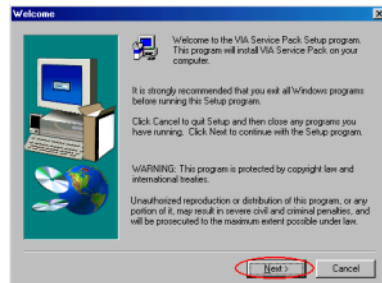

Step 5: You will now see the welcome screen and its dialogue box. Click "Next >" to go on.

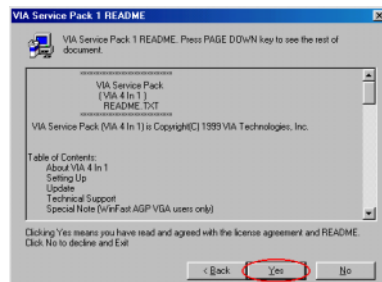

Step 6: The service pack readme screen

will appear. Click the "Yes" button to go on.

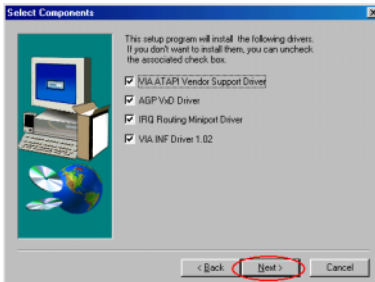

Step 7: This setup program will install the four kinds of drivers. Please check which drivers you want to install. When you choose the items, please click the "Next" button to continue.

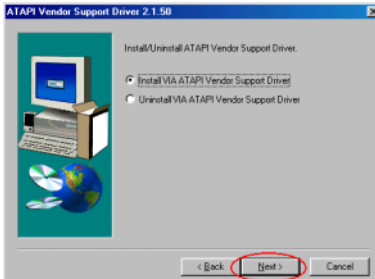

Step 8: Choose the "Install VIA ATAPI Vendor Support Driver" then click the "Next" button to go on.

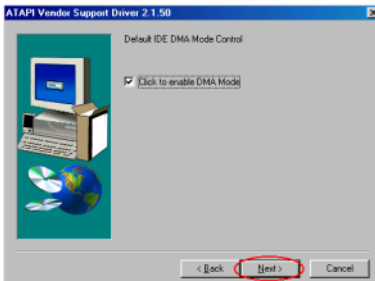

Step 9: Choose "Click to enable DMA mode" then click "Next" button.

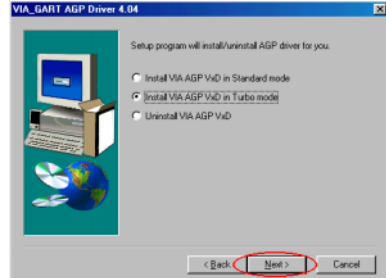

Step 10: Choose the AGP VxD driver mode then click the "Next" button.

Note: What is the difference between "Normal" & "Turbo" mode

Installing in "turbo" mode will give your graphics card enhanced speed and performance while "normal" mode offers increased system stability.

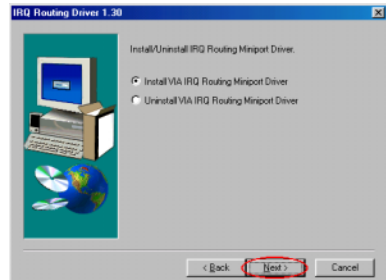

Step 11: Choose "Install VIA IRQ Routing Miniport Driver", then click the "Next" button.

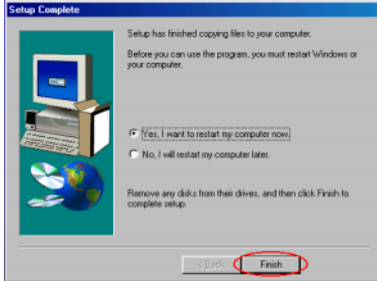

Step 12: When the installation is complete, the installer will ask you to restart your computer. We suggest that you choose “**Yes, I want to restart my computer now**” then click the “**Finish**” button to

restart your computer to finish the driver updates.

When your computer system restarts, will see Windows® 98 SE starts the update process and several new hardware devices will be found and updated. When restarting Windows® 98 SE, the CD-ROM drives will fail to be found in the updating process. If the prompt dialogue box asks you to put the Windows® 98 SE CD into the CD-ROM drive, just ignore this message and let it go to the next process.

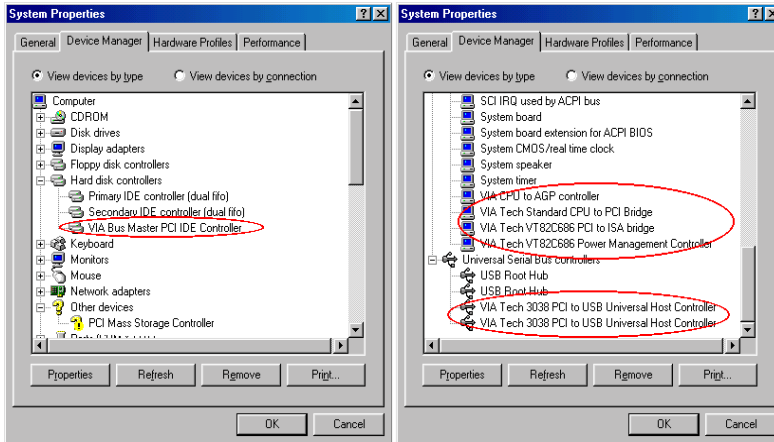

Problem under Windows® 95 OSR2

If your operating system is Windows® 95 OSR2, install the VIA service pack and Microsoft® usbsupp.exe for USB devices support. Then restart Windows and go to **System Properties → Device Manager**. There will be question marks before “**PCI Universal Serial Bus**” and “**VIA PCI to USB Universal Host Controller**”.

To make these question marks disappear, remove these items and then restart Windows. When Windows completes loading, these devices will have returned to normal and the question marks will be gone.

Appendix B Installing the VIA Service Pack Drivers for the Windows® NT 4.0 Server / Workstation

In this section we will show you how to install the VIA Service Pack drives to your Windows® NT 4.0 Server/Workstation operating system. All screen shots are from the Windows® NT 4.0 workstation version. Before you install the VIA Service Pack drives, please install Windows® NT 4.0 Service Pack 5 (or latest version) first. Then you can install the VIA Service Pack drives.

Note

Details of the Windows® NT 4.0 Server/Workstation operating system are not mentioned in this manual. If you have any problems with the settings, operating or installing Windows® NT 4.0 Server/Workstation, please refer to your Windows® NT 4.0 Server/Workstation user's manual or other databases provided by Microsoft® Corporation.

Note

For Windows® NT 4.0 Server/Workstation operating system, you don't need to install the IDE-USB drivers. You have only to install the Windows® NT 4.0 Service Pack 5 (or latest version) first.



Insert the KT7/KT7-RAID/KT7A/K T7A-RAID CD-Title into your CD-ROM drive. It should execute the program automatically. If not, you can go to the CD location and execute the execution file

from the main directory of this CD-Title. After it is executed, you will see the screen to the left.



Step 1: Move the cursor to "Drivers" and click on it. This will bring you to the next screen.



Step 2: Move the cursor to "VIA Chipset Driver" and click on it. Go to the next screen.



Step 3: Move the cursor to "VIA Service Pack" and click on it. Go to the next screen.

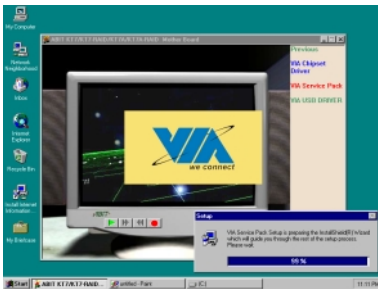

Step 4: You will now see the install shield is loading.

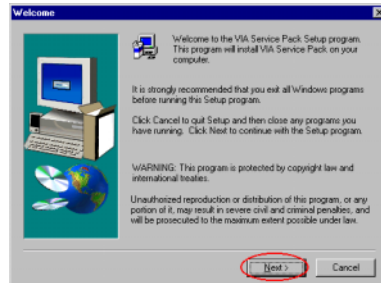

Step 5: The welcome screen and its dialogue box will appear. Click the "Next>" button to go on.



Step 6: The readme screen will appear next. Click the "Yes" button to continue.

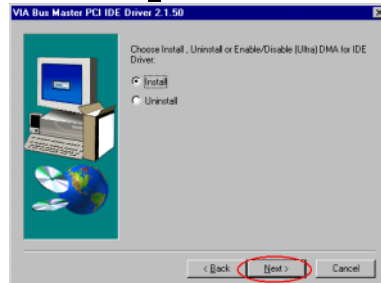

Step 7: Choose "Install" then click the "Next>" button to go on.

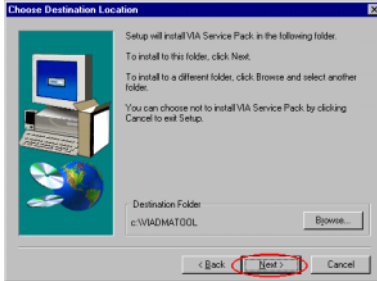

Step 8: Now you can choose the folder for the destination location you want the drivers installed. We suggest you use the default folder as the destination location. After checking the folder click "**Next>**" button.



Step 9: You can choose the name of the program folder. We suggest you use the default program folder name. After checking the program folder name then click "**Next>**" button.

Program will start to install drivers system need.

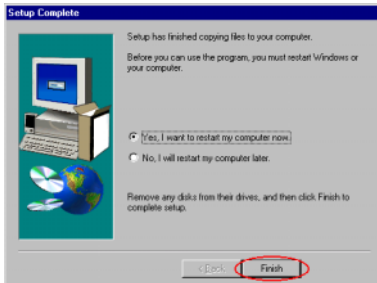

Step 10: When installation is complete, the installer will ask you to restart your computer. We suggest you choose "**Yes, I want to restart my computer now**" then click "**Finish**" button to restart your computer to finish the drivers updating.

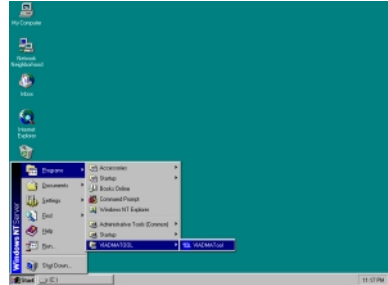

Step 11: When you restart the Windows, you can see the VIA DMA Tools program group.

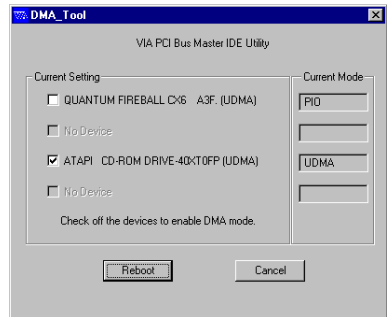

Step 12: You can see the detail about your IDE device.



Appendix C VIA Service Pack Driver Installation for Windows® 2000

Insert the KT7/KT7-RAID/KT7A/KT7A-RAID CD-Title into your CD-ROM drive, it should execute the program automatically. If not, you can go to the CD location and execute the execution file at the main directory of this CD-Title. After it has been executed you will see the screen below

Note

Details of the Windows® 2000 operating system are not mentioned in this manual. If you have any problems with the settings, operating or installing Windows® 2000, please refer to your Windows® 2000 user's manual or other databases provided by Microsoft® Corporation.

Note

Due to the software issue of this Service Pack, it is highly recommended not to replace the IDE or SCSI devices after this Service Pack had been installed under Windows® 2000 operating system.



Step 1: Move the cursor to "Drivers" and click on it. You will go to the next screen.



Step 2: Move the cursor to "VIA Chipset Driver" and click on it. Go to the next screen.



Step 3: Move the cursor to "VIA Service Pack" and click on it. Go to the next screen.

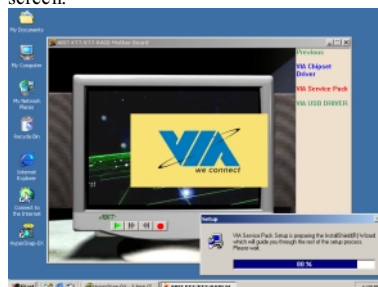

Step 4: Now you will see the install shield loading.

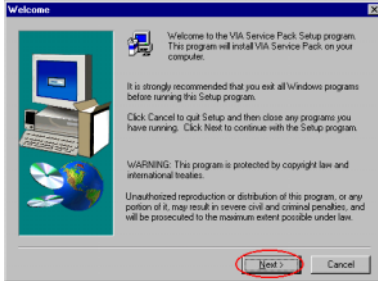

Step 5: You will now see the welcome screen and its dialogue box. Click "**N**ext>" to go on.

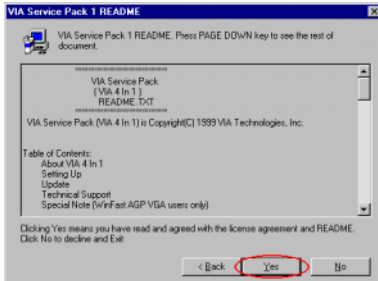

Step 6: The service pack readme screen will appear. Click the "**Y**es" button to go on.



Step 7: This setup program will install the two kinds of drivers. Please check which drivers you want to install. When you choose the items, please click the "**N**ext>" button to continue.

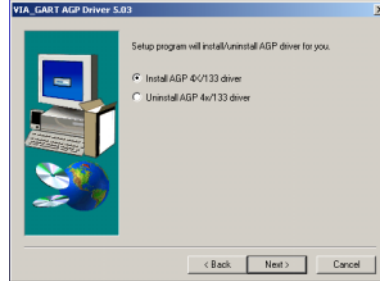

Step 8: Choose "**I**nstall AGP4X/133 Driver", then click the "**N**ext>" button.

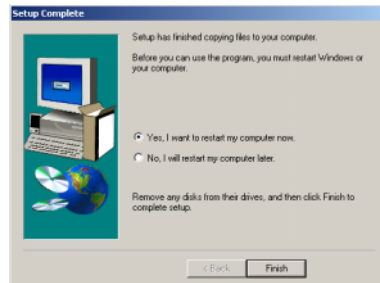

Step 9: When the installation is complete, the installer will ask you to restart your computer. We suggest that you choose "**Y**es, I want to restart my computer now" then click the "**F**inish" button to restart your computer to finish the driver updates.

Appendix D USB Driver Installation Guide

After you install the VIA service pack, you may need to update your USB driver. Please follow the instructions below to finish the installation of the driver. Insert the KT7/KT7-RAID/KT7A/KT7A-RAID CD-Title into your CD-ROM drive, it should execute the program automatically. If not, you can go to the CD location and execute the execution file at the main directory of this CD-Title. After it has been executed, you will see the screen below.



Move the cursor to the **"Drivers"** and click on it. This will take you to the next screen.



Move the cursor to **"VIA Chipset Driver"** and click on it. Go to the next screen.



Move the cursor to **"VIA USB Driver"** and click on it. Go to the next screen.

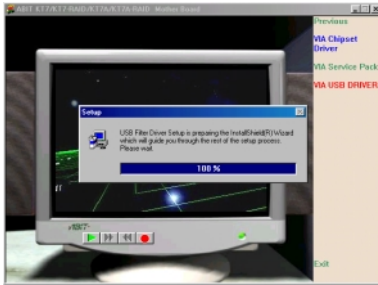

You will see the install shell active.

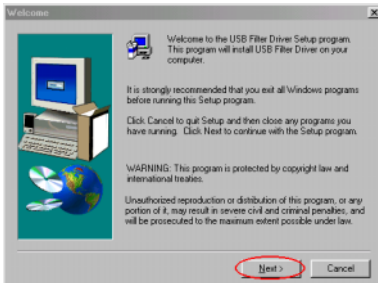

The welcome screen and its dialogue box will appear. Click the "**N**ext>" button to go on.

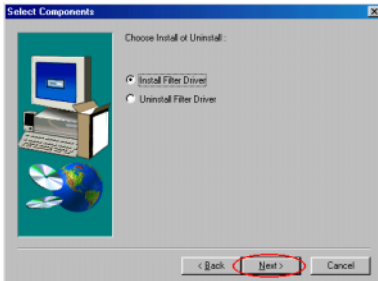

Choose "**I**nstall Filter Driver". Then click the "**N**ext>" button to go on.

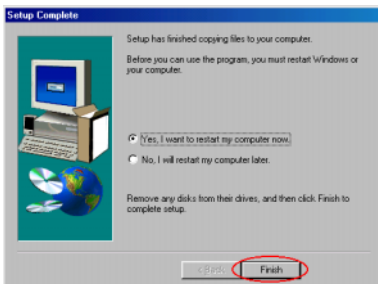

When the installation is complete, the installer will ask you to restart your computer. We suggest that you choose "**Y**es, **I want to restart my computer now**" then click the "**F**inish" button to restart your computer to finish the driver updates.

After reboot, the driver will successfully update.

Appendix E Installing The VIA Hardware Monitor System

VIA Hardware Monitor System is a self-diagnostic system for PCs. It will protect PC hardware by monitoring several critical items including power supply voltages, CPU & system fan speeds, and CPU and system temperatures. These items are important for the operation of the system; errors may result in permanent damage to the PC. Once any item is out of its normal range, a warning message will pop up and remind the user to take proper measures.

The following description will tell you how to install the VIA Hardware Monitor System and use it. Insert the K T7/KT7-RAID/KT7A/KT7A-RAID CD-Title into your CD-ROM drive. It should execute the program automatically. If not, you can go to the CD location and execute the execution file from the main directory of this CD-Title. After it is executed, you will see the screen left.



Click "**VIA Hardware Monitor**" button.



Click "**Install**" button to start install the VIA hardware monitor system utility.



You will see the install shell active.

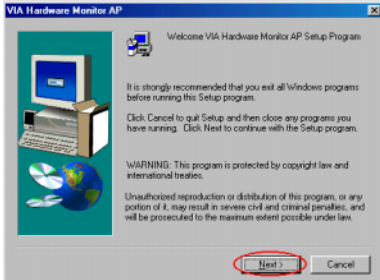

The welcome screen and its dialogue box will appear. Click the "Next" button to go on.

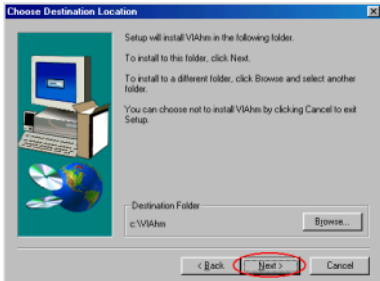

Now you can choose the folder for the destination location you want to install the drivers. We suggest you use the default folder as the destination location. After checking the folder click "Next" button.

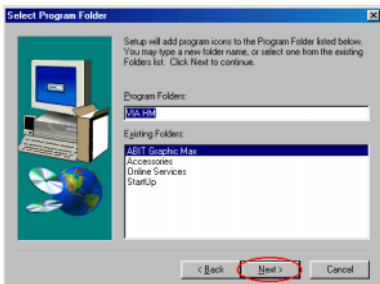

You can choose the name of the program folder. We suggest you use the default program folder name. After checking the program folder name then click "Next" button.

Program will start to install drivers system need.

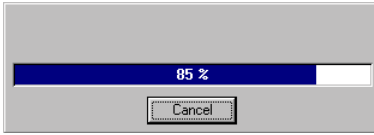

The installer will show the install progress percentage.

When installation is complete, the installer will automatically terminate the install process.

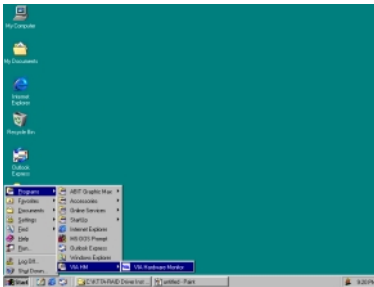

You can call the program from Start toolbar, then choose Programs. You will see the item called “VIA HM” → “VIA Hardware Monitor”. Click it then you can see the screen below.

This screen show the VIA hardware monitor system screen. It shows the information about system temperature, voltages and fan speed. Some items can let you set the warning range; you can accordance your system to make optimize value setting.

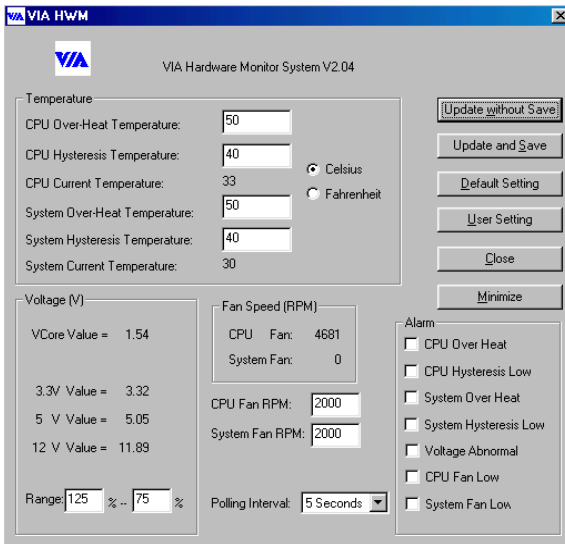



Appendix F BIOS Update Guide

We will use the SE6 as an example, all other models follow the same process.

First, know your motherboard's model name and version number. You can find it on one slot of the motherboard. Each motherboard always has the label at the same place as shown in the photo below.



You will find the model name and version on the white sticker.

2. Know the current BIOS ID.

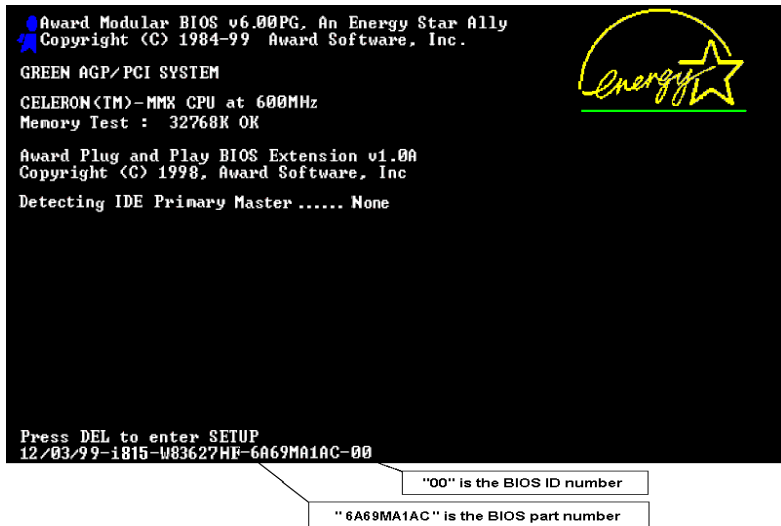

For example, in this case, the current BIOS ID is “00”. If you already have the latest BIOS, no any update action is necessary. If your BIOS is not the latest BIOS, go on to the next step.

3. Download the correct BIOS file from our Web site.

[SE6]

Filename:

[SE6SW.EXE](#)

Date: 07/06/2000

ID: SW

NOTE:

1. Fixes SCSI HDD detection problem when booting from SCSI CD-ROM and executing FDISK.
2. Supports 512MB memory modules.
3. Sets the In-Order Queue Depth default to 4, increasing the integrated video performance.

Go to our Web site and choose the correct BIOS file and download it.

4. Double click the download file, it will self-extract to .bin file.

```
LHA's SFX 2.13$ <c> Yoshi, 1991
SE6_SW.BIN .....
```

5. Make a bootable floppy disk and copy the necessary files onto it.

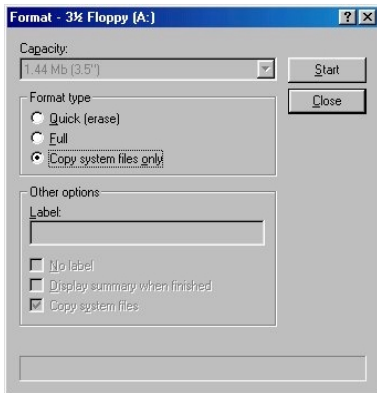

You may make a floppy disk bootable either in Explorer or in the DOS prompt mode.

```
[c:\]format a: /s
```

After formatting and transferring the system to the floppy disk, copy two files into it. One is the BIOS flash utility “awdflash.exe” and the other is the decompressed BIOS binary file.

6. Boot off floppy disk.

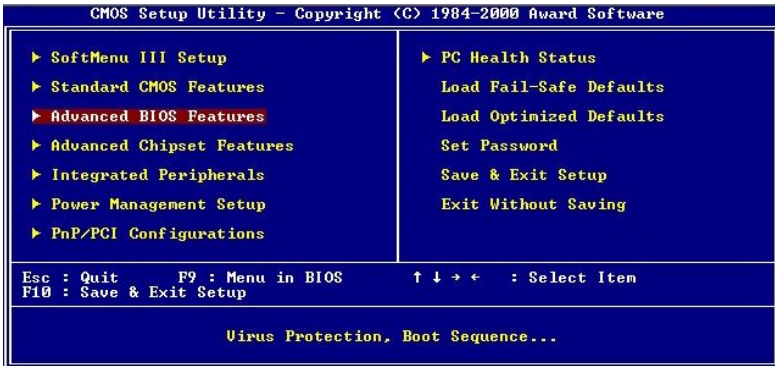

Please set the first boot sequence as “floppy” in BIOS and boot off the floppy disk.

7. Flash the BIOS in pure DOS mode.

```
A:\>awdf flash se6_sw.bin /cc /cd /cp /py /sn /cks /r_
```

After successfully booting off of the floppy, execute the flash utility according to these instructions.

Note

We strongly recommend you use the above parameters following ‘awdf flash’ to flash your BIOS. **DO NOT** just type ‘awdf flash se6_sw.bin’ without the above parameters following the .bin file.

Note

- The Award flash utility can not be completed under a Windows® 95/98 or Windows® NT environment, you must be in a pure DOS environment.
- You should check which BIOS file is to be used with your motherboard, don't flash with the wrong BIOS file. Otherwise, you may cause system malfunctions.

Note

Please do not use the Award flash memory writer version that earlier than Version 7.52C to flash your KT7/KT7-RAID/KT7A/KT7A-RAID motherboard BIOS. Otherwise, it may cause flash fail or un-anticipate problems.

Note

During the updating, the progress will be measured by white blocks. The last four *blue* blocks of the flash update process represent the “BIOS boot block”. The BIOS boot block is used to prevent the BIOS from becoming corrupt during programming. It should not be programmed every time. If this “BIOS boot block” remains intact when the BIOS becomes corrupt during programming, then you can boot from a bootable floppy next time you boot your computer. This allows you to flash your BIOS again without the need for technical support from the dealer.

Appendix G Troubleshooting (Need Assistance?)

Motherboard Troubleshooting:

Q & A:

Q: Do I need to clear the CMOS before I use a new motherboard to assemble my new computer system?

A: Yes, we highly recommend that you clear the CMOS before installing a new motherboard. Please move the CMOS jumper from its default 1-2 position to 2-3 for a few seconds, and then back. When you boot up your system for the first time, follow the instructions in the user's manual to load the optimized defaults.

Q: If my systems hang when I update the BIOS or set the wrong CPU parameters, what should I do?

A: Whenever you update the BIOS or if the system hangs due to wrong CPU parameters setting, always clear CMOS jumper before booting up again.

Q: How can I get a quick response to my request for technical support?

A: Be sure to follow the guidelines as stated in the “**Technical Support Form**” section of this manual.

If you have a problem during operation, in order to help our technical support personnel quickly determine the problem with your motherboard and give you the answers you need, before filling in the technical support form, eliminate any peripheral that is not related to the problem, and indicate it on the form. Fax this form to your dealer or to the company where you bought the hardware in order to benefit from our technical support. (You can refer to the examples given below)



Example 1: With a system including: motherboard (with CPU, DRAM, COAST...) HDD, CD-ROM, FDD, VGA CARD, MPEG CARD, SCSI CARD, SOUND CARD, etc. After the system is assembled, if you cannot boot up, check the key components of the system using the procedure described below. First remove all interface cards except the VGA card and try to reboot.

☛ If you still cannot boot up:

Try installing another brand/model VGA card and see if the system will start. If it still does not start, note the VGA card model, motherboard model, Bios identification number, CPU on the technical support form (refer to main instructions), and describe the problem in the problem description space provided.

☛ If you can boot up:

Insert the interface cards you have removed back into the system, one by one and try to start the system each time you insert a card, until the system will not start. Keep the VGA card and the interface card that caused the problem inserted on the motherboard, remove any other cards or peripheral, and start again. If you still cannot start, note the information related to both cards in the add-on Card space provided, and don't forget to indicate the motherboard model, version, BIOS identification number, CPU (refer to main instructions), and give a description of the problem.



Example 2: With a system including the motherboard (with CPU, DRAM, COAST...) HDD, CD-ROM, FDD, VGA CARD, LAN CARD, MPEG CARD, SCSI CARD, SOUND CARD, after assembly and after having installed the Sound Card Driver, when you restart the system, when it runs the Sound Card Driver, it resets automatically. This problem may be due to the Sound Card Driver. During the Starting DOS... procedure, press SHIFT (BYPASS) key, to skip CONFIG.SYS and AUTOEXEC.BAT; edit CONFIG.SYS with a text editor, and in function the line that loads the Sound Card Driver, add a remark REM, in order to disable the Sound Card Driver. See the example below.

```
CONFIG.SYS:
DEVICE=C:\DOS\HIMEM.SYS
DEVICE=C:\DOS\EMM386.EXE HIGHSCAN
DOS=HIGH, UMB
FILES=40
BUFFERS=36
REM DEVICEHIGH=C:\PLUGPLAY\DWCFGMG.SYS
LASTDRIVE=Z
```

Restart the system. If the system starts and does not reset, you can be sure that the problem is due to the Sound Card Driver. Write down the Sound

Card model, motherboard model, BIOS identification number on the technical support file (refer to main instructions), and describe the problem in the space provided.

☺☺☺ We will show you how to fill the “**Technical Support Form**”.

Main instructions...

To fill in this “Technical Support Form”, refer to the step-by-step instructions given below:

1*. MODEL: Note the model number given in your user’s manual.

Example: KT7A, KT7A-RAID, KT7, KT7-RAID, BX6, BH6, etc...

2*. Motherboard model number (REV): Note the motherboard model number labeled on the motherboard as “REV:*.**”.

Example: REV: 1.01

3*. BIOS ID and Part Number: See next page example.

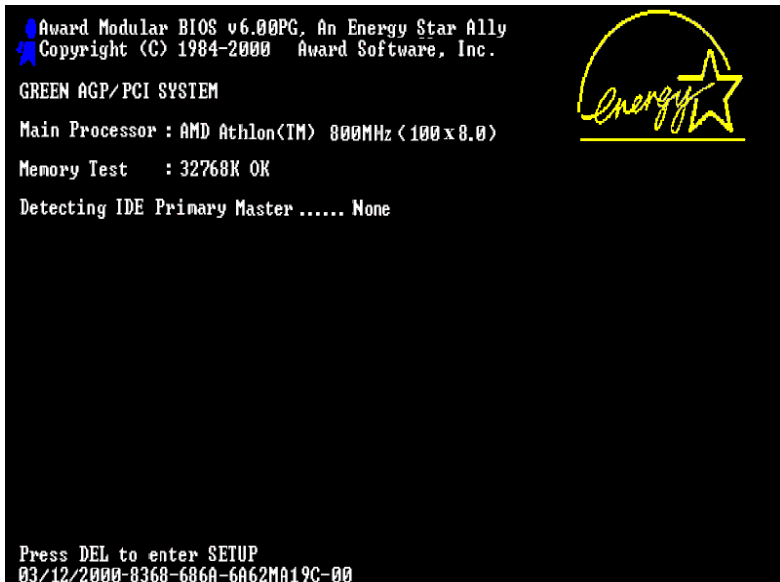

"00" is the BIOS ID number

" 6A62MA19C " is the BIOS part number

4. **DRIVER REV:** Note the driver version number indicated on the DEVICE DRIVER disk (if have) as “Release *.*”. For example:

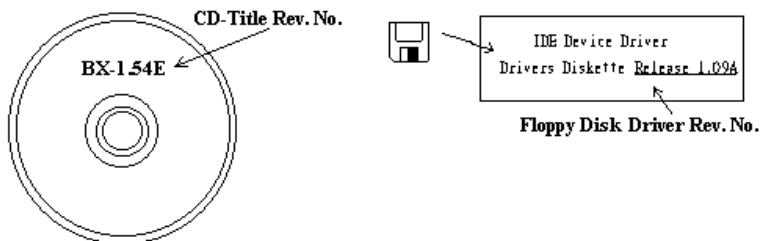

5. **OS/APPLICATION:** Indicate the operating system and the applications you are running on the system.

Example: MS-DOS® 6.22, Windows® 95, Windows® NT...

6. **CPU:** Indicate the brand and the speed (MHz) of your CPU.

Example: (A) In the “Brand” space, write “AMD”, in the “Specifications” space, write “Duron™ 600MHz”.

7. **HDD:** Indicate the brand and specifications of your HDD(s), specify if the HDD is using IDE1 or IDE2. If you know the disk capacity, indicate it and check (“✓”) “”; in case you give no indication, we will consider that your HDD is “ IDE1” Master.

Example: In the “HDD” space, check the box, in the Brand space, write “Seagate”, in the Specifications space, write “ST31621A (1.6GB)”.

8. **CD-ROM Drive:** Indicate the brand and specifications of your CD-ROM drive. Specify if it uses IDE1 or IDE2, and check (“✓”) “”; in case you give no indication, we will consider that your CD-ROM is “ IDE2” Master.

Example: In the “CD-ROM drive” space, check the box, in the Brand space, write “Mitsumi”, in the Specifications space, write “FX-400D”.

9. **System Memory (DRAM):** Indicate the brand and specifications (SIMM / DIMM) of your system memory. For example:

In the Brand space, write “Panasonic”, in the Specifications space, write “SIMM-FP DRAM 4MB-06”.

Or, in the Brand, write “NPNX”, in the Specifications space, write “SIMM-EDO DRAM 8MB-06”.

Or, in the Brand space, write “SEC”, in the Specifications space, write “DIMM-S DRAM 8MB-G12”.

10. ADD-ON CARD: Indicate which add-on cards you are *absolutely sure* are related to the problem.

If you cannot identify the problem’s origin, indicate all the add-on cards inserted into your system.

Note

Items between the “*” are absolutely necessary.

RAID Troubleshooting

Q & A:

Q: May I use hard drives with different capacity or transfer mode?

A: In order to get optimized performance, we suggest using hard drives with the same model.

Q: How to assign a booting device?

A: You may press <Ctrl><H> to assign a booting device in RAID BIOS (user's manual section 3-9).

Q: Why can't I see correct capacity in FDISK utility?

A: It's a well-known issue of Windows® 95/98's FDISK utility. If an IBM 75 GB hard disk DTLA 307075 only gets 7768MB in Windows® 95/98's FDISK utility, please contact Microsoft® for a latest version of FDISK utility or download IBM's Disk Manager DiskGo! 2.5 to fix it. For windows® 2000, there is no such a 64GB issue.

<http://www.storage.ibm.com/techsup/hddtech/welcome.htm>

Q: How to create a striping and mirror array (RAID 0+1)?

A: You need four drives (Appendix A), every two of them on the same channel/cable build a striping array. Then create a mirror array by these two striping arrays (Appendix A-3).

- (i) Press <Ctrl> <H> to setup configuration
- (ii) Choose item 1 to Create RAID.
- (iii) Choose item 1 to set Array Mode as Striping and Mirror (RAID 0+1).
- (iv) Choose item 2 to Select Disk Drives. There are two striping arrays built automatically and you only have to enter twice.
- (v) Choose item 4 to Start Creation Process.
- (vi) Press <Esc> to finish setting and leave RAID BIOS.

Q: How to rebuild a mirror array when one of the drives corrupts?

A: You need to delete previous array setting, duplicate the data, then rebuild a new array setting (user's manual 3-5).

- (i) Press <Ctrl><H> to setup configuration

- (ii) Choose item 2 to Delete Array.
- (iii) Choose item 3 to Duplicate Mirror Disk.
- (iv) Choose sub item 1 to Select Source Disk, the one with data on it.
- (v) Choose sub item 2 to Select Target Disk, the brand new and empty one.
- (vi) Choose sub item 3 to Start Duplication Process.
- (vii) After duplication process completes, press <Esc> to leave RAID BIOS.

Q: Why I see “NO ROM BASIC SYSTEM HALTED” when booting?

A: There isn't any activated primary partition in you system. Please use FDISK or any other utilities to create/set one.

Do & Don't:

1. **Do** always use the same model drives to achieve best quality and performance. Different firmware has different timing characteristic, thus may somewhat decrease the RAID performance.
2. If you have two drives, **do** connect them on two different channels as master drive please.
3. When attach drives to the RAID card, **do** make sure the master/slave jumper settings are correct please. If there is only one drive on one channel/cable, do set it as master or single drive.
4. **Do** always use 80 conductor cables please.
5. **Don't** connect any ATAPI devices (CD-ROM, LS-120, MO, ZIP, removable HD etc.) on the RAID card please.
6. For the best performance result, please **do** use the Ultra ATA 66/100 Hard Disks.

📖 Technical Support Form

 **Company Name:**

 **Phone Number:**

 **Contact Person:**

 **Fax Number:**

 **E-mail Address:**

Model	*	BIOS ID #	*
Motherboard Model No.		DRIVER REV	
OS/Application	*		
Hardware name	Brand	Specifications	
CPU	*		
HDD <input type="checkbox"/> IDE1 <input type="checkbox"/> IDE2			
CD-ROM Drive <input type="checkbox"/> IDE1 <input type="checkbox"/> IDE2			
System Memory (DRAM)			
ADD-ON CARD			



Problem Description:



Appendix H How to Get Technical Support

(From our website) <http://www.abit.com.tw>

(In North America) <http://www.abit-usa.com>

(In Europe) <http://www.abit.nl>

Thank you for choosing ABIT products. ABIT sells all our products through distributors, resellers and system integrators, we have no direct sales to end-users. Before sending email for tech support please check with your resellers or integrators if you need any services, they are the ones who sold you your system and they should know best as to what can be done, how they serve you is a good reference for future purchases.

We appreciate every customer and would like to provide the best service to you. Providing fast service to our customers is our top priority. However we receive many phone calls and a huge amount of email from all over the world. At the present time it is impossible for us to respond to every single inquiry. Therefore it is quite possible that if you send an email to us that you may not receive a response.

We have done many compatibility tests and reliability tests to make sure our products have the best quality and compatibility. In case you need service or technical support, please understand the constraint we have and **always check with the reseller who sold the product to you first.**

To expedite service, we recommend that you follow the procedures outlined below before contacting us. With your help, we can meet our commitment to provide the best service to the **greatest number of ABIT customers:**

1. **Check the Manual.** It sounds simple but we have taken a lot of care in making a well written and thorough manual. It is full of information that doesn't only pertain to motherboards. The CD-ROM included with your board will have the manual as well as drivers. If you don't have either one go to our Program Download Area of the website or FTP server at: <http://www.abit.com.tw/download/index.htm>
2. **Download latest BIOS, software or drivers.** Please go to our Program Download area on our website to check to see if you have the latest BIOS. They are developed over periods of time to fix bugs or incompatibilities. **Also please make sure you have the latest drivers from your peripheral cards makers!**
3. **Check the ABIT Technical Terms Guide and FAQ on our website.** We are trying to expand and make the FAQs more helpful and information rich. Let us know if you have any suggestions. For hot topics check out our HOT FAQ!

4. **Internet Newsgroups.** They are a great source of information and many people there can offer help. ABIT's Internet News group, alt.comp.periphs.mainboard.abit, is an ideal forum for the public to exchange information and discuss experiences they have had with ABIT products. Many times you will see that your question has already been asked before. This is a public Internet news group and it is reserved for free discussions. Here is a list of some of the more popular ones:

alt.comp.periphs.mainboard.abit

comp.sys.ibm.pc.hardware.chips

alt.comp.hardware.overclocking

alt.comp.hardware.homebuilt

alt.comp.hardware.pc-homebuilt

Ask your reseller. Your ABIT authorized distributor should be able to provide the fastest solution to your technical problem. We sell our products through distributors who sell to resellers and stores. Your reseller should be very familiar with your system configuration and should be able to solve your problem much more efficiently than we could. After all, your reseller regards you as an important customer who may purchase more products and who can urge your friends to buy from him or her as well. They integrated and sold the system to you. They should know best what your system configuration is and your problem. They should have reasonable return or refund policies. How they serve you is also a good reference for your next purchase.

5. **Contacting ABIT.** If you feel that you need to contact ABIT directly you can send email to the ABIT technical support department. First, please contact the support team for the branch office closest to you. They will be more familiar with local conditions and problems and will have better insight as to which resellers offer what products and services. Due to the huge number of emails coming in every day and other reasons, such as the time required for problem reproduction, we will not be able to reply to every email. Please understand that we are selling through distribution channels and don't have the resources to serve every end-user. However, we will try to do our best to help every customer. Please also remember that for many of our technical support team English is a second language, you will have a better chance of getting a helpful answer if your question can be understood in the first place. Be sure to use very, simple, concise language that clearly states the problem, avoid rambling or flowery language and always list your system components. Here is the contact information for our branch offices:

**In North America and South America please contact:
ABIT Computer (USA) Corporation**

46808 Lakeview Blvd.
Fremont, California 94538, U.S.A.
sales@abit-usa.com
technical@abit-usa.com
Tel: 1-510-623-0500
Fax: 1-510-623-1092

**In the UK and Ireland:
ABIT Computer Corporation Ltd.**

Unit 3, 24-26 Boulton Road
Stevenage, Herts
SG1 4QX, UK
abituksales@compuserve.com
abituktech@compuserve.com
Tel: 44-1438-228888
Fax: 44-1438-226333

**In Germany and Benelux (Belgium, Netherlands, Luxembourg)
countries:
AMOR Computer B.V. (ABIT's European Office)**

Van Coehoornstraat 7,
5916 PH Venlo, The Netherlands
sales@abit.nl
technical@abit.nl
Tel: 31-77-3204428
Fax: 31-77-3204420

**All other territories not covered above please contact:
Taiwan Head Office**

When contacting our headquarters please note we are located in Taiwan and we are 8+ GMT time. In addition, we have holidays that may be different from those in your country.

ABIT Computer Corporation

3F-7, No. 79, Sec. 1, Hsin Tai Wu Rd.

Hsi Chi, Taipei Hsien, Taiwan

sales@abit.com.tw

market@abit.com.tw

technical@abit.com.tw

Tel: 886-2-2698-1888

Fax: 886-2-2698-1811

RMA Service. If your system has been working but it just stopped, but you have not installed any new software or hardware recently, it is likely that you have a defective component. Please contact the reseller from whom you bought the product. You should be able to get RMA service there.

6. **Reporting Compatibility Problems to ABIT.** Because of tremendous number of email messages we receive every day, we are forced to give greater weight to certain types of messages than to others. For this reason, any compatibility problem that is reported to us, giving detailed system configuration information and error symptoms, will receive the highest priority. For the other questions, we regret that we may not be able to reply directly. But your questions may be posted to the internet news group in order that a larger number of users can have the benefit of the information. Please check the news group from time to time.
7. Listed below are some chipset vendors' WEB site addresses for your reference:
 - ALI's WEB site: <http://www.ali.com.tw/>
 - Highpoint Technology Inc.'s WEB site: <http://www.highpoint-tech.com/>
 - Intel's WEB site: <http://www.intel.com/>
 - SiS' WEB site: <http://www.sis.com.tw/>
 - VIA's WEB site: <http://www.via.com.tw/>

Thank you, ABIT Computer Corporation

<http://www.abit.com.tw>